

PREMIUM EXTERIOR DOORS

**CODEL**  
**DOORS**  
Fiberglass & Steel





SF8SDL1P doors with Carbon paint.



# CODEL DOORS

**Complete & Ontime DELivery!**

*Featuring Fiberglass and Steel entry doors.*

## Table of Contents

The CODEL Difference .....	4-5
Door Skins and Textures .....	6-7
New Products.....	8
Design Ideas.....	9-13
<b>Contemporary Classics</b>	
6-8 & 7-0 Contemporary Classics Collection.....	14-15
8-0 Contemporary Classics Collection.....	16-17
Decorative Contemporary Classics Collection.....	18
Engraved Contemporary Classics & Textured Fiberglass Teak .....	19
<b>Craftsman</b>	
6-8 Standard Craftsman Collection.....	20-21
6-8 & 8-0 Smooth Fiberglass Heritage Craftsman Collection.....	22-25
6-8 & 8-0 Fir-Grain Fiberglass Heritage Craftsman Collection.....	26-29
<b>Commodity Doors</b>	
Smooth Fiberglass Standard Collection.....	30-33
Smooth Fiberglass Flush-Glazed Collection.....	34-35
Smooth Fiberglass Direct Glazed Contemporary Collection.....	36-37
Smooth Fiberglass Flush-Glazed Contemporary Collection.....	38
Oak Grain Textured Fiberglass Standard Collection .....	39-41
Oak Grain Textured Fiberglass Flush-Glazed Collection.....	42-43
Fir Grain Textured Fiberglass Direct Glazed Contemporary.....	44-45
Fir Grain Textured Fiberglass Collection.....	46
Premium Shaker Fiberglass Collection.....	47-51
Rustic Fiberglass Collection .....	52-53
Steel Standard Collection.....	54-55
90-Minute "Fast-Frame" Fire Doors.....	56-57
Single-Hinged Inswing Fiberglass Patio Doors .....	58-59
Traditional Patio Doors.....	60-61
"Retro" Double Doors.....	62
Swinging Patio .....	63

### Decorative Collections

<b>NEW</b> Eastmont .....	64-65	Eloquence .....	82-83
<b>NEW</b> Perimeter.....	66-67	Floret.....	84-85
<b>NEW</b> Royston.....	68-69	Harlow .....	86-87
<b>NEW</b> Sable .....	70-71	Maren.....	88-89
Adelaide.....	72-73	Modena.....	90-91
Artisan .....	74-75	Narrows.....	92-93
Brentwood .....	76-77	Niagara .....	94-95
Canterbury.....	78-79	Satin Etch.....	96-97
Chord .....	80-81	Waterton.....	98-99

Obscure Glass Options .....	100
Specialty Glass Options.....	101
Split Finish.....	102-103
WeatherGuard Frame.....	104
Adjustable Sill Pan & Jamb Options.....	105
Sills.....	106
Hinges.....	107
Hoppe MultiPoint Hardware .....	108
Rockwell MultiPoint.....	109-110
Contemporary Door Pulls.....	111
Codel Door Configurations.....	112-113
Decorative Transom Sizes & Door Handing .....	114
Prehung Net Unit Measurements.....	115

**Cover Photo:** Heritage SFHER-303 with (x2) SFHER-280 sidelites.

## Style & Beauty

Traditional to Classic, Craftsman to Contemporary. Codel offers a wide selection of styles and collections to best suit your own design.



## Secure

MultiPoint lock hardware options or a heavy duty steel plate to reinforce the latch jamb against break-in force, offers more security and peace of mind.



### Heavy Duty Steel Plate

Reinforces jamb against break-in force.



### MultiPoint Lock Hardware

(Optional)

Increases resistance against break-in force.

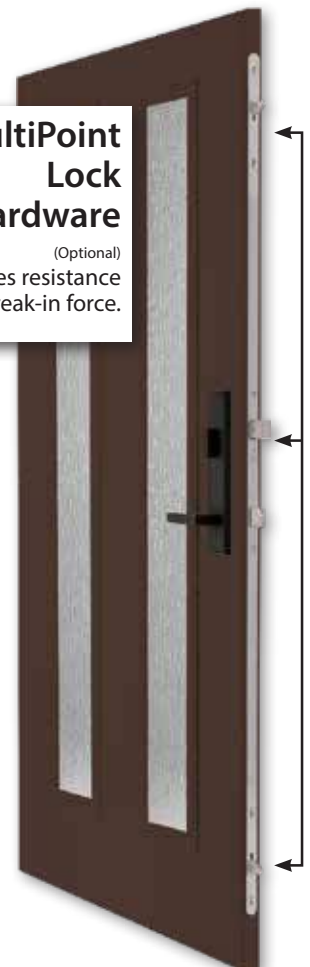

# Efficient

Codel doors provide more insulation value than wood doors and are more efficient than older, worn-out, drafty doors. Low-E and Argon is standard in our decorative glass doors.



Low-Emissivity (Low-E) and Argon is standard in our decorative glass for improved energy performance. Low-E is standard on all of our Commodity doors with glass.

## Thermal Performance values established in accordance with ETC Laboratories (NFRC) Simulation Report

	R value	U value	SHGC value
Fiberglass Full Panel door unit w/no glass	6.25	0.16	0.00
Fiberglass door unit w/1/2 Low-E Glass	4.17	0.24	0.16
Fiberglass door unit w/3/4 Low-E Glass	3.85	0.26	0.21
Fiberglass door unit w/Full Low-E Glass	3.45	0.29	0.28
Fiberglass door unit w/1/2 Low-E Mini Blind Glass	3.57	0.28	0.11
Fiberglass door unit w/3/4 Low-E Mini Blind Glass (blind up)	3.33	0.30	0.18
Fiberglass door unit w/Full Low-E Mini Blind Glass	2.94	0.34	0.22
Fiberglass door unit w/1/4 Low-E Decorative Glass	5.00	0.20	0.07
Fiberglass door unit w/1/2 Low-E Decorative Glass	4.55	0.22	0.13
Fiberglass door unit w/3/4 Low-E Decorative Glass	4.17	0.24	0.17
Fiberglass door unit w/Full Low-E Decorative Glass	3.85	0.26	0.23
Fiberglass door unit w/Full Flush Glazed Low-E Glass	3.70	0.27	0.32
Fiberglass door unit w/Full Flush Glazed Low-E Mini Blind Glass	3.03	0.33	0.22

# Quality Features

## WeatherGuard Jamb

(Optional)  
Composite jambs resist moisture, rotting, splitting and termites.



**LIMITED LIFETIME WARRANTY**  
ALL Codel fiberglass doors come with a **LIFETIME LIMITED WARRANTY**

## Corner Seal

Added protection against water and air infiltration.

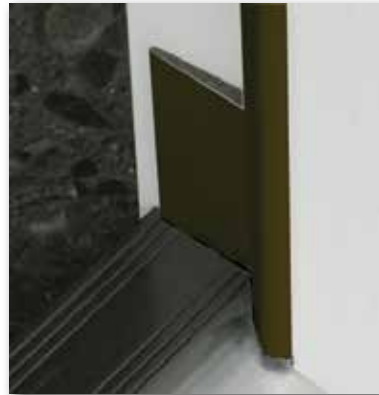

## Commercial-Grade Ball Bearing Hinges

Designed to operate smoother and longer. Non-ferrous now standard on all outswing doors to prevent rusting.



**HydroShield technology**  
**Composite Perimeter**  
Protects against moisture damage.

**Heavy Duty Lockblock**  
Solid lockblock for greater strength and durability.

Not Available in Wood-Edge or Steel Doors.

**Smooth Fiberglass SF**



See pages 30-38 for Smooth Fiberglass doors.

**"Oak" Textured Fiberglass TF**

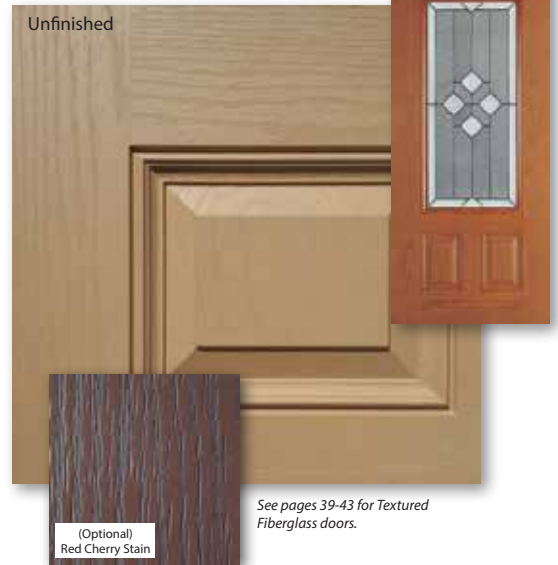

See pages 39-43 for Textured Fiberglass doors.

**Premium Shaker Smooth Fiberglass SF or Fir Grain FG**



See page 46-51 for Smooth & Fir Grain Fiberglass doors.

**Heritage Craftsman Fir-Grain FG or Smooth Fiberglass SF**



See pages 22-29 for Heritage Craftsman Collection.

**Premium Smooth Smooth Fiberglass SF**



See page 30 for Smooth Fiberglass doors.



**Paint or Stain, we've got you covered!**

Steel **S**



"Teak" Textured Fiberglass



"Rustic" Textured Fiberglass **RF**



Flush Cherry Engraved



Professional factory painting or staining  
for a beautiful finish.  
(See back of brochure for additional colors.)

**NEW**  
**6/8 3-Equal Smooth  
 Fiberglass and Fir-Grain  
 Shaker Doors**

See pages 30 & 46.



SF3PESHK

FG3PESHK

FGSL

**NEW**  
**Direct Glazed  
 Contemporary  
 Collection**

See pages 36-37 & 44-45.



SF20D 6/8 & 8/0  
 (Available in FG also)

SF20D1P 6/8 & 8/0  
 (Brushed Smooth Finish)

**NEW**  
**6/8  
 3/4 2-Panel Oak  
 Textured Door**

See page 39.



TF2PL

**NEW**  
**Low-E Glass is NOW Standard on ALL Doors**

See pages  
 30-37, 39-43  
 & 55.



**NEW**  
**8/0 1-Panel & 2-Panel  
 Smooth Fiberglass  
 Shaker Doors**

See page 30-31.

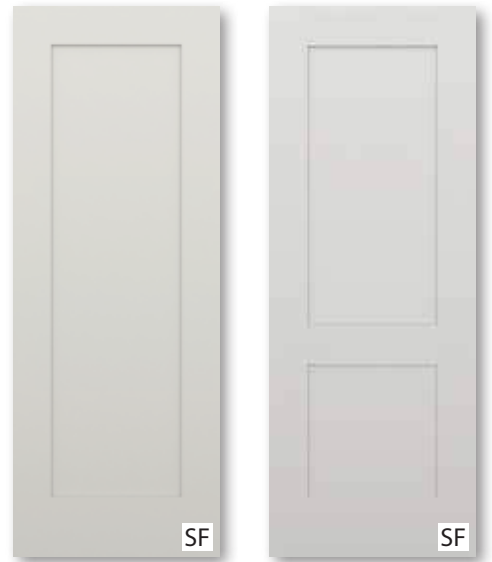

SF1PSHK80

SF2PSHK80

**NEW**  
**Decorative Glass and Textured Glass Options**

See pages 64-71.



Sable

Eastmont

Perimeter

Royston

**NEW**  
**Non-ferrous  
 hinges are now  
 standard on  
 outswing doors**

See page 107.







**Modern Contemporary**

*Featuring simple forms and geometric lines, contemporary houses are designed to fit today's lifestyles. The style encompasses a variety of distinctive elements, often featuring unconventional shapes and innovative details. Contemporary homes are often much warmer in design than modern versions. In general, contemporary homes try to bring the interior and exterior together.*



*Satin Etch  
CON-2236  
(See page 16.)*



*Chord  
CHO-460  
(See page 80.)*

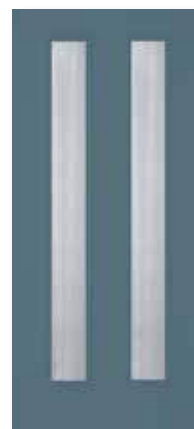

*Sable  
CON-7642 with  
Codel Coatings  
Denim Paint  
(See page 15.)*



*SF20F4L  
Flush-Glazed  
Contemporary  
with applied  
Aluminum  
Mullion Bars  
Satin Etch  
(See page 38.)*



## Modern Farmhouse

*A balanced blend of modern and rustic, the Modern Farmhouse style continues to be a rising trend. We paired some of our favorite door and glass options that intelligently mix modern and traditional.*

*FG3ESHK  
(See page 46.)*



*Eastmont  
EAS-4401P with Codel  
Coatings Fremont Paint  
(See page 64.)*



*Adelaide  
FGHADE-200  
(See page 27.)*



*SF6SDL1P  
(See page 32.)*



**Contemporary Northwest**

*Contemporary homes reflect the architecture and design of today. They represent smart design and curb appeal. We selected several doors that we believe represent the ethos of now and can be loved forever.*



*Clear  
CON-2235 with  
Codel Coatings  
Proctor Paint  
(See page 14.)*



*Sable  
CON-7642  
(See page 15.)*



*Chord  
CHO-460  
(See page 80.)*



*SF20F4L  
Flush-Glazed  
Contemporary  
with applied  
Aluminum  
Mullion Bars  
Satin Etch  
(See page 38.)*



**Craftsman**

Craftsman homes emphasize hand-worked touches and beautiful detailing. Popularized at the turn of the 20th Century, it remains a popular design aesthetic. We have recommended several door and glass options that give you the beautiful detailing a craftsman home requires.



*Artisan  
ART-4301P  
(See page 74.)*



*Narrows  
NAR-460 with  
Codel Coatings  
Cougar Paint  
(See page 92.)*



*Adelaide  
SFHADE-200  
(See page 23.)*



*Waterton  
WAT-64  
(See page 98.)*



*Beveled Glass  
FLS-200 with  
Codel Coatings  
Artichoke Paint  
(See page 21.)*



**Traditional**

*Traditional homes are comforting and classic. Their interiors are calm, orderly and predictable. Everything matches and is consistent. We suggest these doors for completing the look in a traditional home style and décor.*



**Floret**  
FLO-1842OV  
(See page 85.)



**Adelaide**  
ADE-4401P  
(See page 72.)



**Niagara**  
NIA-430 with  
Codel Coatings  
Ballard Paint  
(See page 94.)



**Eloquence**  
ELO-440  
(See page 82.)



**Canterbury**  
CAN-460  
(See page 78.)

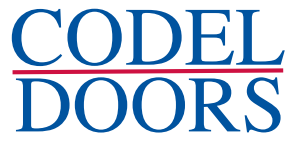

## 6/8 & 7/0 Contemporary Classics

(Textured Fiberglass available upon request. Contact your Codel Rep. for details.)

CON-2285 door and (2) CON-865SL sidelites with Clear glass and Bright paint.



Daylight Glass Size 21" x 2-1/2"

SF

CON-2235  
6-8 (28 210 30 36)  
7-0 (28 30 36)



Daylight Glass Size 21" x 7"

SF

CON-2285  
6-8 (28 210 30 36)  
7-0 (28 30 36)

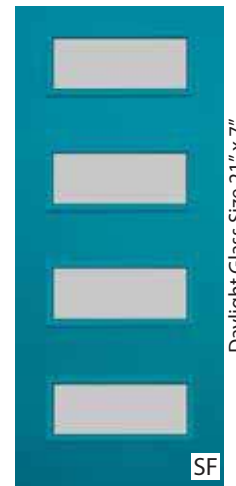

Daylight Glass Size 21" x 7"

SF

CON-2284  
6-8 (28 210 30 36)  
7-0 (28 30 36)

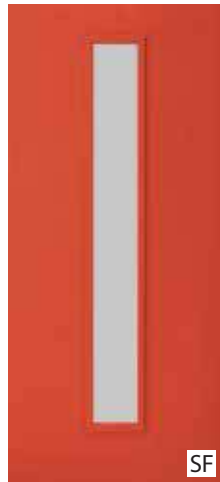

Daylight Glass Size 6" x 63"

SF

CON-764C  
6-8 (28 210 30 36)  
7-0 (28 30 36)



Daylight Glass Size 6" x 63"

SF

CON-764S  
6-8 (28 210 30 36)  
7-0 (28 30 36)



Daylight Glass Size 6" x 63"

SF

CON-764SL  
(12" & 14")



Daylight Glass Size 7" x 5"

SF

CON-865C  
6-8 (28 210 30 36)  
7-0 (28 30 36)



Daylight Glass Size 7" x 5"

SF

CON-865S  
6-8 (28 210 30 36)  
7-0 (28 30 36)



Daylight Glass Size 7" x 5"

SF

CON-865SL  
(14")

SF Smooth Fiberglass



Daylight Glass Size 21" x 9"

SF

CON-22103  
6-8 (28 210 30 36)  
7-0 (28 30 36)



Daylight Glass Size 21" x 9"

SF

CON-22104  
6-8 (28 210 30 36)  
7-0 (28 30 36)



Daylight Glass Size 21" x 14-1/4"

SF

CON-22153  
6-8 (28 210 30 36)  
7-0 (28 30 36)



Daylight Glass Size 21" x 2-1/2" (4) & 21" x 14-1/4" (1)

SF

CON-221534  
6-8 (28 210 30 36)  
7-0 (28 30 36)



Daylight Glass Size 6" x 63" (x 2)

SF

CON-7642  
6-8 (28 210 30 36)  
7-0 (28 30 36)



Daylight Glass Size 7" x 7"

SF

CON-884C  
6-8 (28 210 30 36)  
7-0 (28 30 36)



Daylight Glass Size 7" x 7"

SF

CON-884S  
6-8 (28 210 30 36)  
7-0 (28 30 36)



Daylight Glass Size 7" x 7"

SF

CON-884SL  
(14")



Bottom Lite Available on Hinge Side

Daylight Glass Size 2-1/2" x 21"

SF

CON-3223  
6-8 (28 210 30 36)  
7-0 (28 30 36)



Daylight Glass Size 7" x 7"

SF

CON-884D  
6-8 (28 210 30 36)  
7-0 (28 30 36)

## Stock Glass Options



Clear/Low-E



Sable



Satin Etch



Chord



Contemporary Low Profile Lite Frame

## Paint Options



Color samples are reproduced as close as possible, actual color may vary.

**CODEL  
DOORS**

**8/0  
Contemporary Classics  
(Smooth Fiberglass Only)**



Contemporary Classics CON-221535 door with Flint paint.



Daylight Glass Size 21" x 2-1/2"

CON-2236  
(28 30 36)

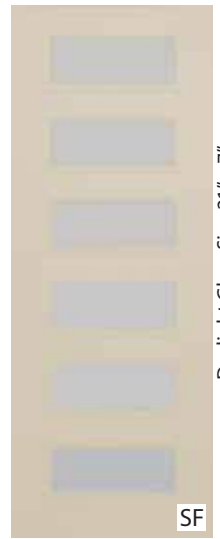

Daylight Glass Size 21" x 7"

CON-2286  
(28 30 36)



Daylight Glass Size 21" x 2-1/2" (5) & 21" x 14-1/4" (1)

CON-221535  
(28 30 36)

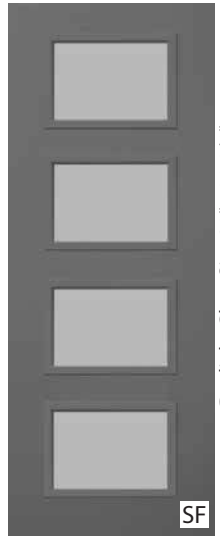

Daylight Glass Size 21" x 14-1/4"

CON-22154  
(28 30 36)

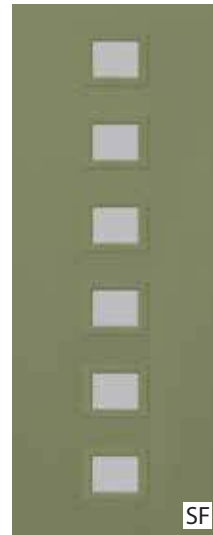

Daylight Glass Size 7" x 5"

CON-866C  
(28 30 36)

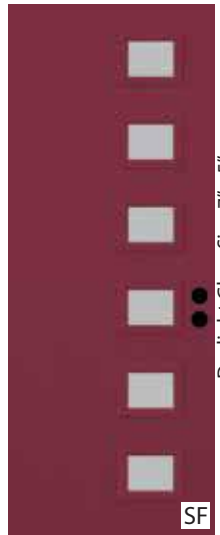

Daylight Glass Size 7" x 5"

CON-866S  
(28 30 36)

SF Smooth Fiberglass



# Stock Glass Options



CON-2285  
(28 30 36)



CON-2210480  
(28 30 36)



CON-2210580  
(28 30 36)



CON-885C  
(28 30 36)



CON-885S  
(28 30 36)



CON-885SL  
(14")

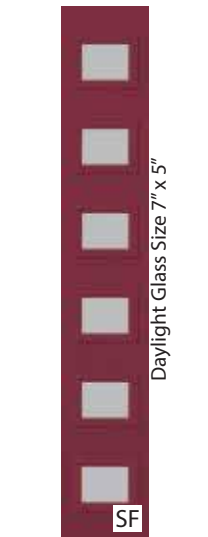

CON-866SL  
(14")



CON-885D  
(28 30 36)



Clear/Low-E



Sable



Satin Etch



Chord

# Paint Options



FREMONT



PROCTOR



COUGAR



TOMATO



BURGUNDY



HUNTER



ARTICHOKE



NAVY



PACIFIC



BALLARD



DENIM

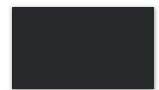

CARBON



IRON



FLINT



CONCRETE



ESPRESSO



TRUFFLE



TAUPE

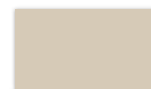

SAND

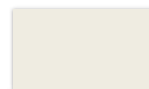

IVORY



BRIGHT

Color samples are reproduced as close as possible, actual color may vary.

# Decorative Contemporary Classics



ART-22153  
6-8 (28 210 30 36)  
7-0 (28 30 36)

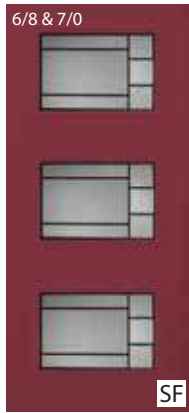

MOD-22153  
6-8 (28 210 30 36)  
7-0 (28 30 36)



HAR-22153  
6-8 (28 210 30 36)  
7-0 (28 30 36)

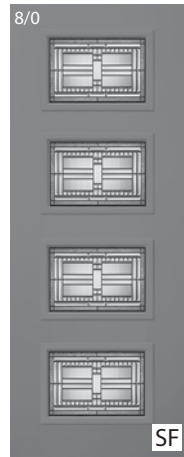

ART-22154  
(28 30 36)

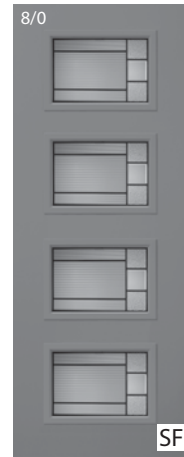

MOD-22154  
(28 30 36)



HAR-22154  
(28 30 36)

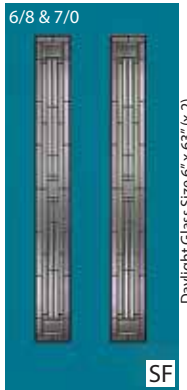

ART-7642  
6-8 (28 210 30 36)  
7-0 (28 30 36)

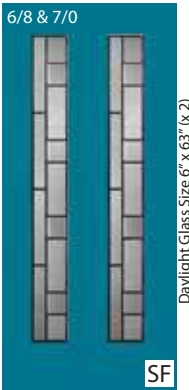

MOD-7642  
6-8 (28 210 30 36)  
7-0 (28 30 36)

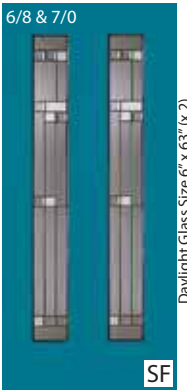

HAR-7642  
6-8 (28 210 30 36)  
7-0 (28 30 36)

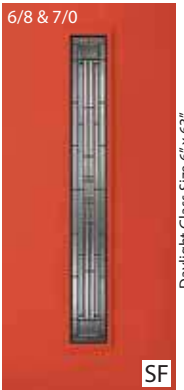

ART-764C  
6-8 (28 210 30 36)  
7-0 (28 30 36)



MOD-764C  
6-8 (28 210 30 36)  
7-0 (28 30 36)



HAR-764C  
6-8 (28 210 30 36)  
7-0 (28 30 36)

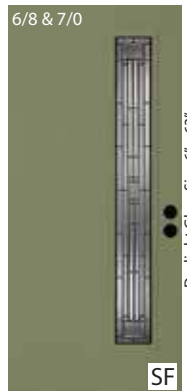

ART-764S  
6-8 (28 210 30 36)  
7-0 (28 30 36)



MOD-764S  
6-8 (28 210 30 36)  
7-0 (28 30 36)



HAR-764S  
6-8 (28 210 30 36)  
7-0 (28 30 36)

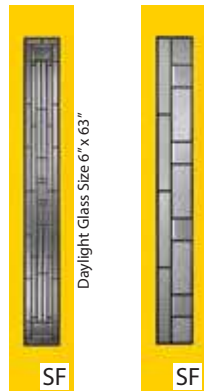

ART-764SL  
6-8 (12" & 14")  
7-0 (12" & 14")



MOD-764SL  
6-8 (12" & 14")  
7-0 (12" & 14")



HAR-764SL  
6-8 (12" & 14")  
7-0 (12" & 14")



HAR-764S with Artichoke paint.

Contemporary Low Profile Lite Frame

## Paint Options



Color samples are reproduced as close as possible, actual color may vary.

# Flush Cherry Engraved Contemporary Classics

Our high-quality fiberglass door designs complement the architectural style of contemporary homes. These doors contain engravings for a striking front entrance.



Flush Cherry Engraved Contemporary Classics CON-C501 door. Stain shown is not Codel Coatings.



CON-C499  
6-8 (30)  
8-0 (30 36)



CON-C498  
6-8 (14")  
8-0 (14")



CON-C500  
6-8 (30)  
8-0 (30 36)



CON-C501  
6-8 (30)



CON-C551  
8-0 (30 36)



Unfinished  
Flush Cherry

Doors shown here are stained with Ginger stain. (See back cover for additional stain options.)



TFT door. Stain shown is not Codel Coatings.

# Textured Fiberglass Teak Contemporary Classics



TFT  
6-8 (30)



Unfinished Teak  
(See back cover for Stain options.)

**CODEL  
DOORS**



# 6/8 Standard Craftsman



FLS-200 door with Denim paint. Shown with optional dentil shelf.



Adelaide - Patina Caming

ADE-200 (30)



ADE-160 (12" & 14")



Maren - Patina Caming

MAR-200 (30)

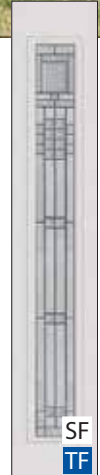

MAR-160 (12" & 14")



Narrows - Patina Caming

NAR-200 (30)

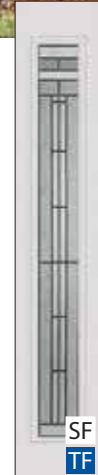

NAR-160 (12" & 14")



Waterton - Patina Caming

WAT-200 (30)



WAT-160 (12" & 14")

SF Smooth Fiberglass TF Textured Fiberglass Doors shown with optional C-21P shelf.



## 6/8 & 8/0 Craftsman 4-Panel Collection

FLF-64  
FLF-6480  
(30)

SPR-64  
SPR-6480  
(30)

NO  
Door Shelf  
Available



■ FLF-6312 / FLF-6712 / FLF-7212  
 Refer to Page 106 for Transom Size Information.  
 ■ Extended Leadtime Required.

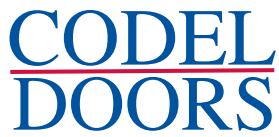

SFHADE-200 door with Flint paint. Shown with optional dentil shelf.

# 6/8 Smooth Fiberglass Heritage Craftsman

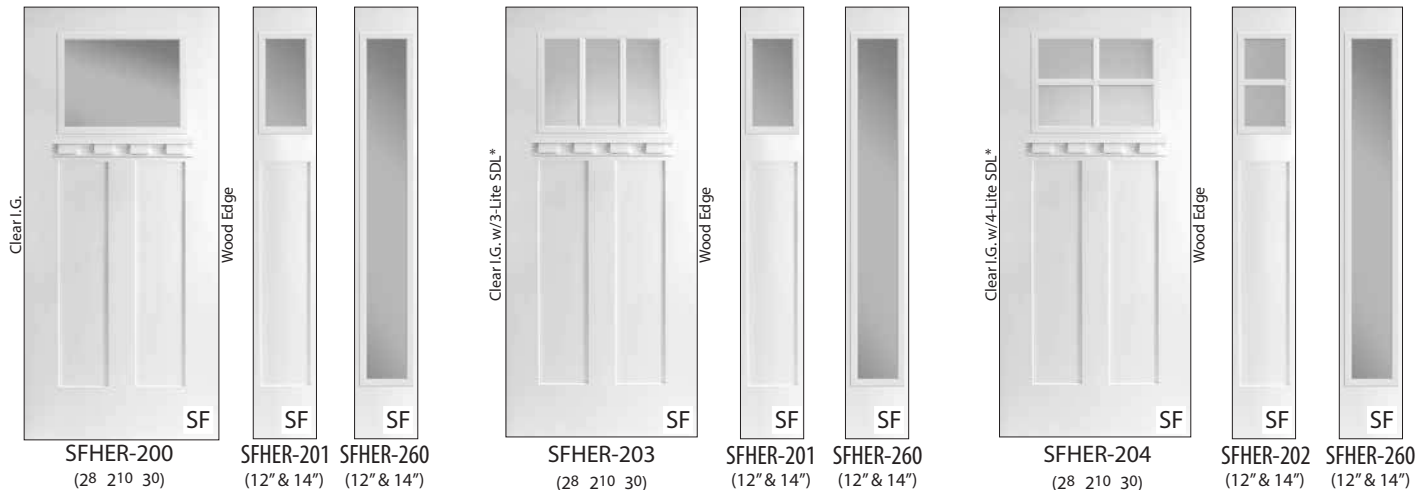

SF Smooth Fiberglass - \*SDI: Simulated Divided Lite - Additional Obscure Glass Options Available, See Page 100. - Doors shown with optional C21P Craftsman Shelf.

# 6/8 Smooth Fiberglass Heritage Craftsman

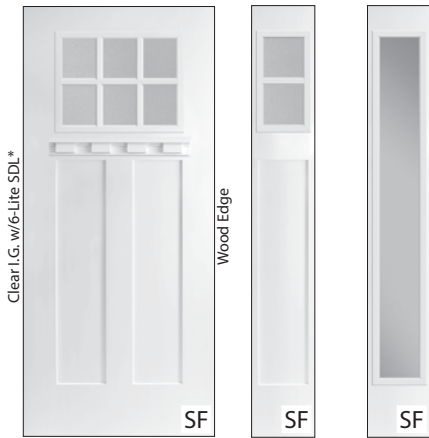

SFHER-206  
(28 210 30)



SFHER-202  
(12" & 14")



SFHER-260  
(12" & 14")



SFHFLS-200  
(28 210 30)



SFHFLF-201  
(12" & 14")



SFHFLF-260  
(12" & 14")

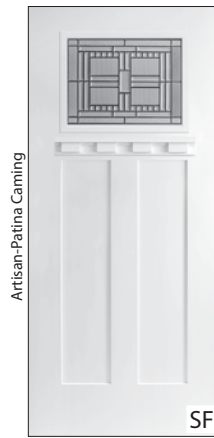

SFHART-200  
(28 210 30)



SFHART-201  
(12" & 14")



SFHART-260  
(12" & 14")



SFHNNAR-200  
(28 210 30)



SFHNNAR-201  
(12" & 14")



SFHNNAR-260  
(12" & 14")



SFHADA-200  
(28 210 30)



SFHADA-201  
(12" & 14")



SFHADA-260  
(12" & 14")



SFHMOD-200  
(28 210 30)



SFHMOD-201  
(12" & 14")



SFHMOD-260  
(12" & 14")

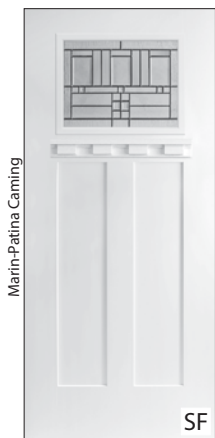

SFHMAR-200  
(28 210 30)



SFHMAR-201  
(12" & 14")

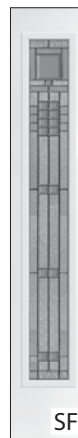

SFHMAR-260  
(12" & 14")



SFHWAT-200  
(28 210 30)



SFHWAT-201  
(12" & 14")



SFHWAT-260  
(12" & 14")

## Heritage Lite Kit Frame



Lite kit frame features clean, classic lines, and is reglazeable.

## Simulated Divided Lite



Simulated divided lite bars are 5/16" thick x 1-1/8" wide.

## C-21P Craftsman Shelf



(Optional)



Color samples are reproduced as close as possible, actual color may vary.

# 8/0 Smooth Fiberglass Heritage Craftsman



SFHER-300 door with Cougar paint. Shown with optional dentil shelf.

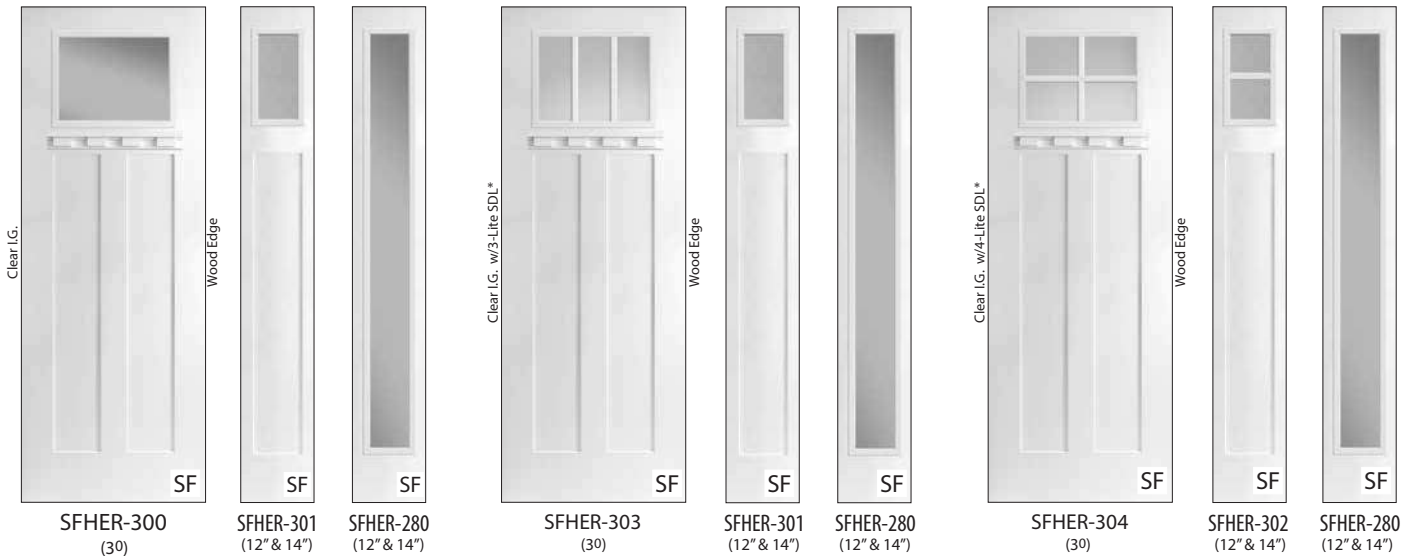

Smooth Fiberglass - \*SDL: Simulated Divided Lite - Additional Obscure Glass Options Available, See Page 100. - Doors shown with optional C21P Craftsman Shelf.



# 8/0 Smooth Fiberglass Heritage Craftsman



Clear I.G. w/6-Lite SDL\*

SF

SFHER-306  
(30)



Wood Edge

SF

SFHER-302  
(12" & 14")



SF

SFHER-280  
(12" & 14")



Beveled Glass, Clear I.G./Patina Caming

SF

SFHFLS-300  
(30)



Wood Edge

SF

SFHFLF-302  
(12" & 14")



Artisan - Patina Caming

SF

SFHART-300  
(30)



Wood Edge

SF

SFHART-301  
(12" & 14")



SF

SFHART-280  
(12" & 14")



Narrow - Patina Caming

SF

SFHNAR-300  
(30)



Wood Edge

SF

SFHNAR-301  
(12" & 14")



Adelaide - Patina Caming

SF

SFHADE-300  
(30)



Wood Edge

SF

SFHADE-301  
(12" & 14")



SF

SFHADE-280  
(12" & 14")



Modena - Patina Caming

SF

SFHMOD-300  
(30)



Wood Edge

SF

SFHMOD-301  
(12" & 14")



SF

SFHMOD-280  
(12" & 14")



Maren - Patina Caming

SF

SFHMAR-300  
(30)



Wood Edge

SF

SFHMAR-301  
(12" & 14")



Waterton - Patina Caming

SF

SFHWAT-300  
(30)



Wood Edge

SF

SFHWAT-301  
(12" & 14")



SF

SFHWAT-280  
(12" & 14")

**Heritage Lite Kit Frame**

Lite kit frame features clean, classic lines, and is reglazeable.

**Simulated Divided Lite**

Simulated divided lite bars are 5/16" thick x 1-1/8" wide.

**C-21P Craftsman Shelf**

(Optional)



Color samples are reproduced as close as possible, actual color may vary.

# 6/8 Fir-Grain Textured Fiberglass Heritage Craftsman

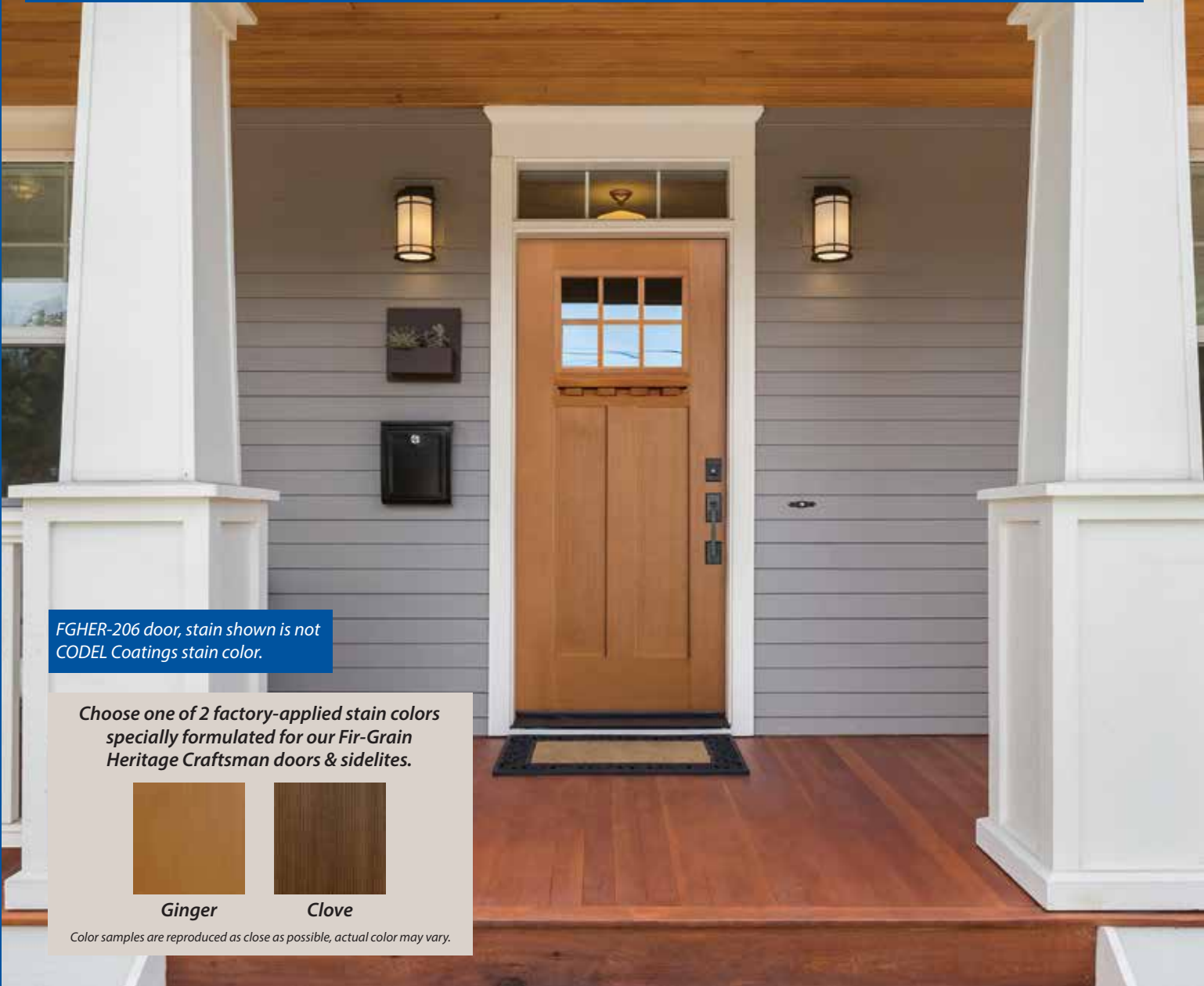

FGHER-206 door, stain shown is not CODEL Coatings stain color.

Choose one of 2 factory-applied stain colors specially formulated for our Fir-Grain Heritage Craftsman doors & sidelites.



Ginger



Clove

Color samples are reproduced as close as possible, actual color may vary.



Clear I.G.

Wood Edge

FG

FGHER-200  
(28 210 30)



FG

FGHER-201  
(12" & 14")



FG

FGHER-260  
(12" & 14")



Clear I.G. w/3-lite SDL\*

Wood Edge

FG

FGHER-203  
(28 210 30)



FG

FGHER-201  
(12" & 14")



FG

FGHER-260  
(12" & 14")



Clear I.G. w/4-lite SDL\*

Wood Edge

FG

FGHER-204  
(28 210 30)



Clear I.G. w/2-lite SDL\*

FG

FGHER-202  
(12" & 14")



FG

FGHER-260  
(12" & 14")

# 6/8 Fir-Grain Textured Fiberglass Heritage Craftsman



**Heritage Lite Kit Frame**



Lite kit frame features clean, classic lines, and is reglazable.

**Simulated Divided Lite**



Simulated divided lite bars are 5/16" thick x 1-1/8" wide.

**C-21F Craftsman Shelf**



(Optional)

# 8/0 Fir-Grain Textured Fiberglass Heritage Craftsman



Choose one of 2 factory-applied stain colors specially formulated for our Fir-Grain Heritage Craftsman doors & sidelites.



Ginger



Clove

Color samples are reproduced as close as possible, actual color may vary.

FGHER-304 door. Stain color shown is not Codel Coatings.



FGHER-300 (30)



FGHER-301 (12" & 14")



FGHER-280 (12" & 14")



FGHER-303 (30)



FGHER-301 (12" & 14")



FGHER-280 (12" & 14")



FGHER-304 (30)



FGHER-302 (12" & 14")



FGHER-280 (12" & 14")

# 8/0 Fir-Grain Textured Fiberglass Heritage Craftsman



Clear I.G. w/6-Lite SDL\*  
 FGHER-306 (30)    FGHER-302 (12" & 14")    FGHER-280 (12" & 14")



Beveled Glass Clear I.G. / Patina Caming  
 FGHFLS-300 (30)    FGHFLF-302 (12" & 14")



Artisan-Patina Caming  
 FGHART-300 (30)    FGHART-301 (12" & 14")    FGHART-280 (12" & 14")



Narrows-Patina Caming  
 FGHNAR-300 (30)    FGHNAR-301 (12" & 14")



Adelaide-Patina Caming  
 FGHADE-300 (30)    FGHADE-301 (12" & 14")    FGHADE-280 (12" & 14")



Modena-Patina Caming  
 FGHMOD-300 (30)    FGHMOD-301 (12" & 14")    FGHMOD-280 (12" & 14")



Maren-Patina Caming  
 FGHMAR-300 (30)    FGHMAR-301 (12" & 14")



Waterton-Patina Caming  
 FGHWAT-300 (30)    FGHWAT-301 (12" & 14")    FGHWAT-280 (12" & 14")

**Heritage Lite Kit Frame**



Lite kit frame features clean, classic lines and is reglazeable.

**Simulated Divided Lite**

Simulated divided lite bars are 5/16" thick x 1-1/8" wide.

**C-21F Craftsman Shelf**



*(Optional)*

## Smooth Fiberglass Collection



SF8SDL1P doors with Carbon paint.

### Key Code Chart

GBG ..... Available w/Grids between Glass

LE ..... Low-E Standard

● ..... Available in 7<sup>0</sup> Height

▲ ..... Available in 8<sup>0</sup> Height

■ ..... Extended Leadtime Required

◆ ..... Available w/Panic Blocking/  
Closure Reinforcement (6-8 Only)

🔥 ..... 20-Min. Fire Rated (\*6-8 Only, 3-0 Max Width.)

SFF/SFF20

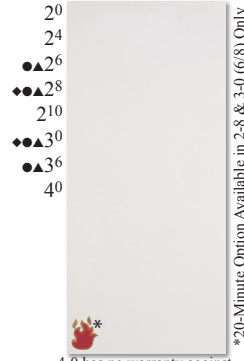

4-0 has no warranty against bowing or wavy skin.

SF6P/SF6P20



SF4P



SF3P



SF3E



SF3PESHK



SF2PSHK



SF3PSHK

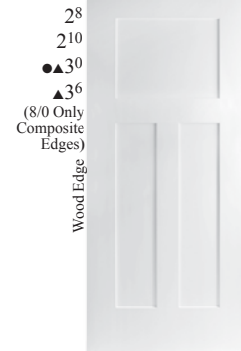

See Page 23 For Optional Craftsman Shelf,  
Glass and Sidelite Options.

SF5PSHK

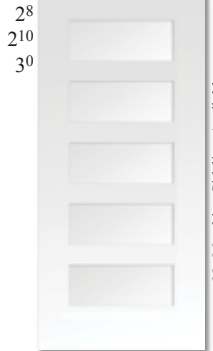

SFW



GBG

SFC



SF622



**Low-E Glass Standard**

**We Finish What We Start!**



<p><b>SF81MB2P</b></p> <p>30 Raise &amp; Lower Mini Blinds</p>	<p><b>SF811P</b></p> <p>▲30 Raise &amp; Lower Mini Blinds</p>	<p><b>SF4SDL1P</b></p> <p>30 Simulated Divided Lite. No Matching Sidelites Available.</p>	<p><b>SF6SDL1P</b></p> <p>30 Simulated Divided Lite. No Matching Sidelites Available.</p>	<p><b>SF81V1P</b></p> <p>30 Vented Glass w/screen</p>	<p><b>SF81MB1P</b></p> <p>30 Raise &amp; Lower Mini Blinds</p>
<p><b>SF611P</b></p> <p>28 210 ▲30 Raise &amp; Lower Mini Blinds</p>	<p><b>SF291P</b></p> <p>28 210 30 GBG Only</p>	<p><b>SF691P</b></p> <p>28 210 30 Fixed Grids Standard</p>	<p><b>SF6V1P</b></p> <p>28 210 30 Vented Glass w/screen</p>	<p><b>SF61MB1P</b></p> <p>28 210 30 Raise &amp; Lower Mini Blinds</p>	<p><b>SF611PC</b></p> <p>28 30 Raise &amp; Lower Mini Blinds</p>
<p><b>SF291PC</b></p> <p>28 30 GBG Only</p>	<p><b>SF691PC</b></p> <p>28 30 Fixed Grids Standard</p>	<p><b>SF6V1PC</b></p> <p>28 30 Vented Glass w/screen</p>	<p><b>SF61MB1PC</b></p> <p>28 30 Raise &amp; Lower Mini Blinds</p>	<p><b>SF611PSHK</b></p> <p>28 210 30 Raise &amp; Lower Mini Blinds</p>	<p><b>SF291PSHK</b></p> <p>28 210 30 GBG Only</p>
<p><b>SF691PSHK</b></p> <p>28 210 30 Fixed Grids Standard</p>	<p><b>SF6V1PSHK</b></p> <p>28 210 30 Vented Glass w/screen</p>	<p><b>SF61MB1PSHK</b></p> <p>28 210 30 Raise &amp; Lower Mini Blinds</p>	<p><b>SF1</b></p> <p>●26 ●▲28 ●210 ●▲30 ●▲36 Raise &amp; Lower Mini Blinds</p>	<p><b>SF20</b></p> <p>●20 ●24 ●26 ●▲28 ●210 ●▲30 ●▲36 2/0 &amp; 2/4 Glass size is 14x64, 3/6 Glass is 26 x 64 (6-8 &amp; 7-0) 3/6 Glass is 22 x 80 (8-0)</p>	<p><b>SF9</b></p> <p>●26 ●▲28 ●210 ●▲30 ●▲36 GBG Only 3/6 Glass is 22 x 64</p>

**Low-E Glass Standard**



Color samples are reproduced as close as possible, actual color may vary.



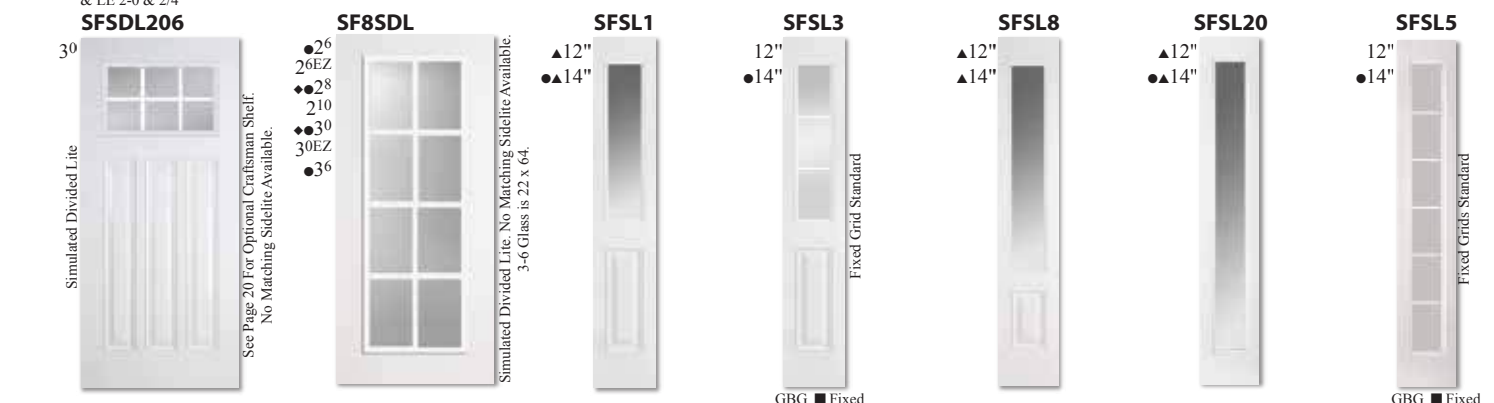

SF6SDL2P door. Paint color shown is not Codel Coatings.



Color samples are reproduced as close as possible, actual color may vary.

# CODEL DOORS

Low-E  
Standard

Smooth Fiberglass

## Flush-Glazed Collection

(Including GBG & SDL Bars)



SF20FMB Flush-Glazed door with Bright paint.

### Key Code Chart

- GBG ..... Available w/ Grids between Glass
- LE ..... Low-E Standard
- ..... Available w/ Extended Leadtime

## Flush-Glazed & Flush-Glazed with Grids Between Glass (GBG)

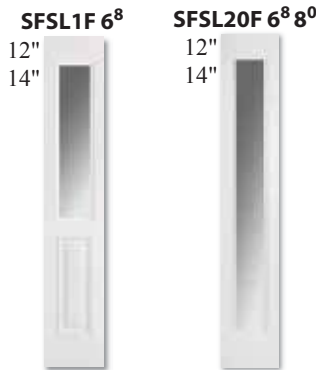
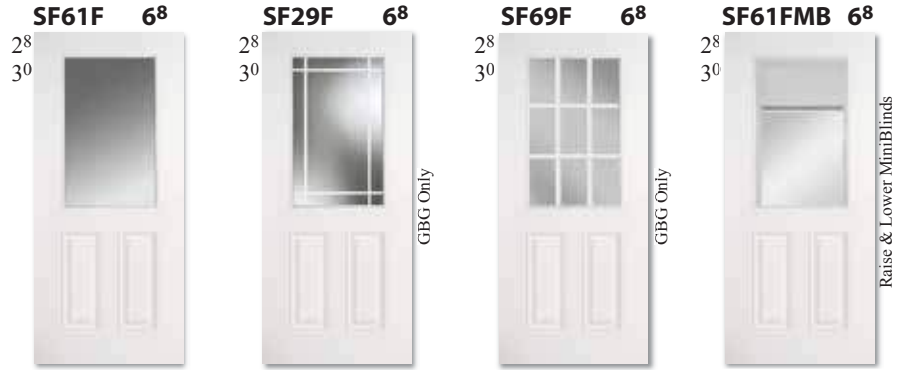

## Grids Between Glass (GBG)

Grids Between Glass (GBG) are flat bars between the glass that are inserted at the time the glass is made, showing the grid but leaving a smooth glass surface for easy cleaning.



Low-E is now our  
Standard on all  
Commodity glass.  
We also offer a  
high-performance  
Low-E called Low-E  
366. Contact your  
Codel Rep. for more  
information.

# Simulated Divided Lites (SDL)

Simulated Divided Lite (SDL) doors are created by installing SDL bars on the face of the glass in the door. These bars are applied to both sides of the glass to create the look of a true divided lite while maintaining the energy efficiency value of a single lite.



SDL Bar Profile

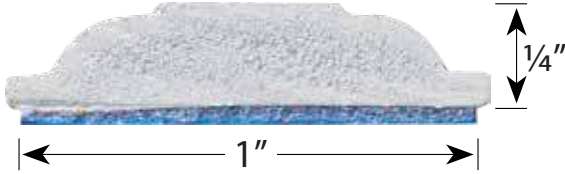

- Available in 6/8, 7/0 & 8/0 Heights
- Extended Leadtime Required
- No Finishing Available on Traditional SDL Doors

## 6/8, 7/0 & 8/0 Flush-Glazed Simulated Divided Lites (SDL)

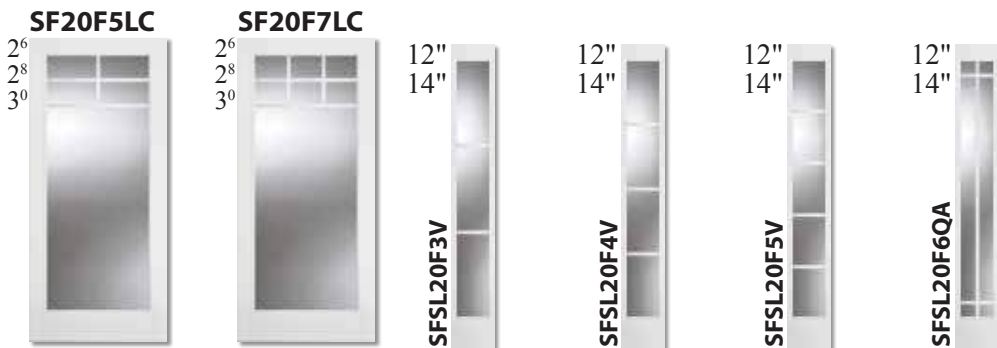

Smooth Fiberglass

# Direct Glazed Contemporary Collection

The SF Direct Glazed Collection features glass that is directly glazed into the door to create a seamless blend between the glass and door. The large glass pane allows the most scenery and natural light into your home. This generous portion of glass is available in two models: the 20D with a traditional, Craftsman sticking, in a Smooth or Fir skin (see pages 44-45), and the 20D1P with a modern, Shaker sticking and Brushed Smooth finish.



SF20D door. Paint color shown is not Codel Coatings.

## SF20D1P

### Modern, Shaker Sticking and a Brushed Smooth Finish



Brushed Smooth Finish



20D1P Sticking

Available in Brushed Smooth Fiberglass Only

## SF20D

### Traditional, Craftsman Sticking in Smooth Fiberglass

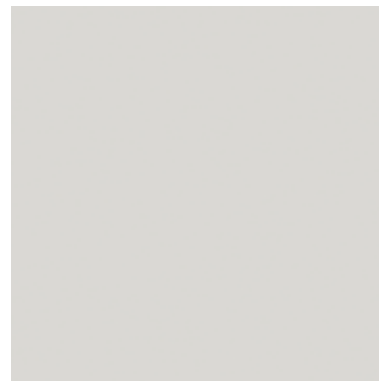

Smooth Finish

Also available in Fir Grain Fiberglass (see pages 44-45)

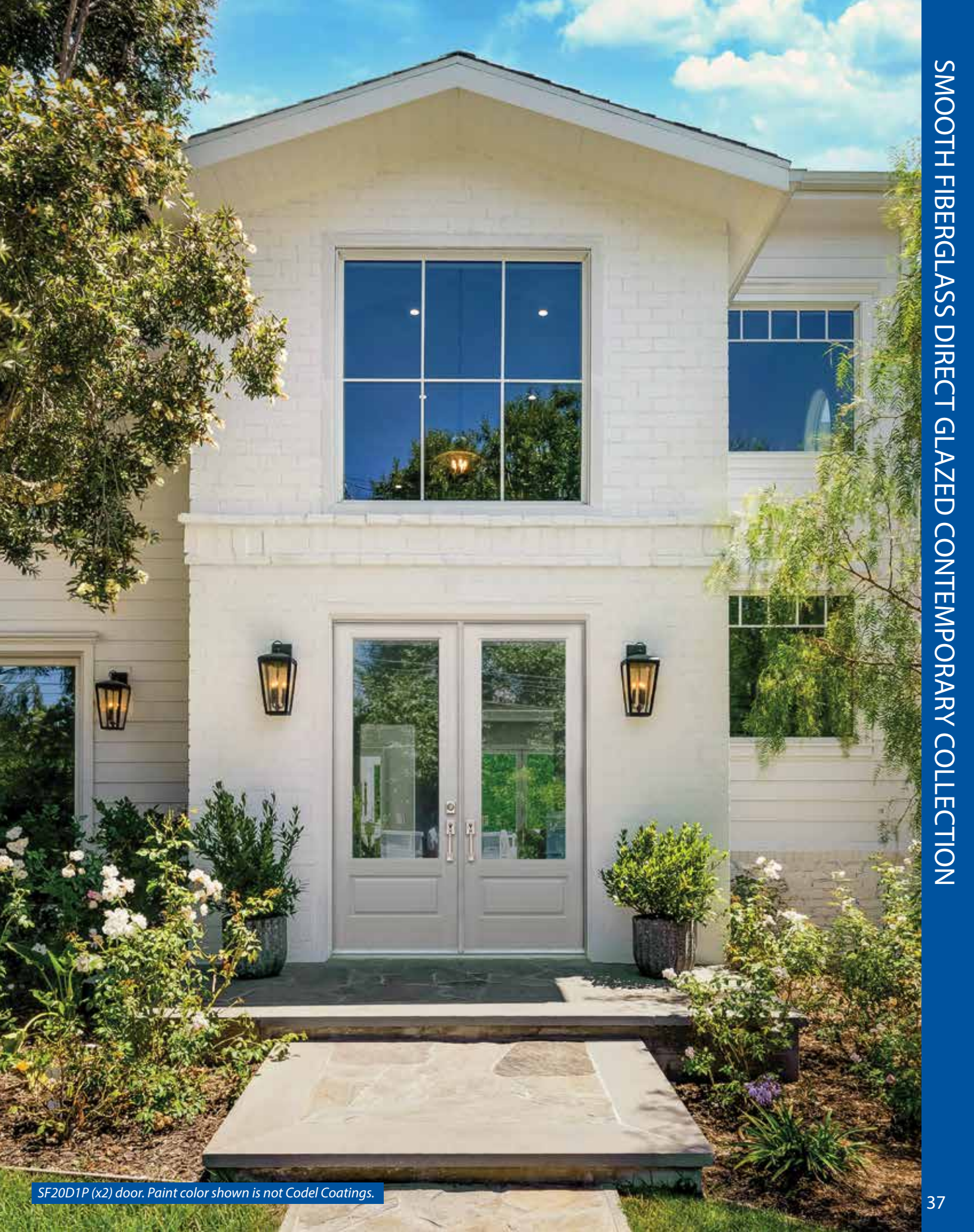

SF20D1P (x2) door. Paint color shown is not Codel Coatings.



# Smooth Fiberglass Flush-Glazed Contemporary Collection

Our sleek Aluminum Mullion Bars compliment the clean lines of our flush-glazed smooth fiberglass door. With 5 door styles to choose from, you can create that unique entry you've been looking for. Available in Low-E and Satin Etch.



SF20F3L door and (2) SFSL20F3L3.5 sidelites with Satin Etch glass, finished with Codel Coatings Carbon paint.

## NEW Mullion Bars Available in 2 Sizes



- Flush-Glazed Door Available in 6-8, 7-0, 8-0 & EZ-Fit Heights
- 3-1/2" & 4-1/2" Aluminum Mullion Bars Will Not Shrink
- Matching Sidelites Also Available
- 5/8" OA Glass ONLY

### STYLES

<p>2<sup>0</sup> 2<sup>4</sup> 2<sup>6</sup> 2<sup>8</sup> 2<sup>10</sup> 3<sup>0</sup></p>	<p>2<sup>0</sup> 2<sup>4</sup> 2<sup>6</sup> 2<sup>8</sup> 2<sup>10</sup> 3<sup>0</sup></p>	<p>2<sup>0</sup> 2<sup>4</sup> 2<sup>6</sup> 2<sup>8</sup> 2<sup>10</sup> 3<sup>0</sup></p>	<p>2<sup>0</sup> 2<sup>4</sup> 2<sup>6</sup> 2<sup>8</sup> 2<sup>10</sup> 3<sup>0</sup></p>	<p>2<sup>8</sup> 2<sup>10</sup> 3<sup>0</sup></p>	<p>12" 14"</p>	<p>12" 14"</p>
SF20F2L3.5 SF20F2L4.5	SF20F3L3.5 SF20F3L4.5	SF20F4L3.5 SF20F4L4.5	SF20F5L3.5 SF20F5L4.5	SF20F3VL3.5 SF20F3VL4.5	SFSL20F3L3.5 SFSL20F3L4.5	SFSL20F5L3.5 SFSL20F5L4.5



Color samples are reproduced as close as possible, actual color may vary.

# CODEL DOORS

Oak Grain

## Textured Fiberglass Collection

Low-E  
Standard



TF6SDL2P door with Cinnamon stain.

### Key Code Chart

GBG ..... Available w/Grids Between Glass

LE ..... Low-E Standard

▲ ..... Available in 8<sup>0</sup> Height

■ ..... Available w/Extended Leadtime.

 ..... 20-Min. Fire Rated (6-8 Only)

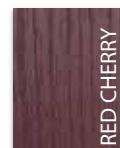
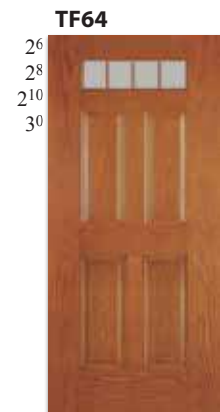

Color samples are reproduced as close as possible, actual color may vary.

<p><b>TF64C</b></p> <p>▲30</p>	<p><b>TF64GBG</b></p> <p>▲30</p> <p>28 210 30</p> <p>GBG only</p>	<p><b>TF648CL</b></p> <p>28 210 30</p>	<p><b>TFC</b></p> <p>26 28 210 30</p>	<p><b>TFW</b></p> <p>26 28 210 30</p> <p>Fixed Grid Standard</p>	<p><b>TF622</b></p> <p>26 28 210 ▲30</p> <p>LE 6-8 / ■ LE 8-0</p>
<p><b>TF61</b></p> <p>26 28 210 ▲30</p> <p>LE</p>	<p><b>TF29</b></p> <p>■26 28 210 30</p> <p>GBG &amp; LE</p>	<p><b>TF69</b></p> <p>26 28 210 30</p> <p>GBG, GBG &amp; LE / ■ Fixed Grid &amp; LE</p> <p>Fixed Grid Standard</p>	<p><b>TF6V</b></p> <p>26 28 210 30</p> <p>LE Vented Glass w/screen</p> <p>Lite kit available in white only.</p>	<p><b>TF61MB</b></p> <p>26 28 210 30</p> <p>GBG</p> <p>LE 2-8, 2-10, 3-0 ■ LE 2-6</p> <p>Raise &amp; Lower Mini Blinds</p>	<p><b>TF1</b></p> <p>26 ▲28 ▲30</p> <p>LE</p>
<p><b>TF81</b></p> <p>28 ▲30 36 (8-0 Only)</p> <p>LE</p>	<p><b>TF4SDL2P</b></p> <p>28 30</p> <p>Simulated Divided Lite</p> <p>NEW</p>	<p><b>TF6SDL2P</b></p> <p>28 30</p> <p>Simulated Divided Lite</p>	<p><b>TF81MB2P</b></p> <p>28 30</p> <p>Raise &amp; Lower Mini Blinds</p> <p>NEW</p>	<p><b>TF81V2P</b></p> <p>28 30</p> <p>Lite kit available in white only.</p> <p>NEW</p>	<p><b>TF811P</b></p> <p>28 30</p> <p>LE</p> <p>NEW</p>
<p><b>TF4SDL1P</b></p> <p>28 30</p> <p>NEW</p>	<p><b>TF6SDL1P</b></p> <p>28 30</p> <p>NEW</p>	<p><b>TF81MB1P</b></p> <p>28 30</p> <p>Raise &amp; Lower Mini Blinds</p> <p>NEW</p>	<p><b>TF81V1P</b></p> <p>28 30</p> <p>Lite kit available in white only.</p> <p>NEW</p>	<p><b>TF20</b></p> <p>▲26 ▲28 210 ▲30 30EZ</p> <p>LE 6-8 &amp; 7-0, 2-8 &amp; 3-0 8-0 ■ LE 2-6 8-0</p>	<p><b>TF20V</b></p> <p>28 210 30 30EZ</p> <p>LE, Vented w/Screen</p>



Color samples are reproduced as close as possible, actual color may vary.





TF4P door. Stain color shown is not Codel Coatings.

# CODEL DOORS

Low-E  
Standard

## Oak Grain Textured Fiberglass Flush-Glazed Collection

(Including GBG & SDL Bars)



TF20F Flush-Glazed door. Stain color shown is not Codel Coatings.

## Flush-Glazed & Flush-Glazed with Grids Between Glass (GBG)

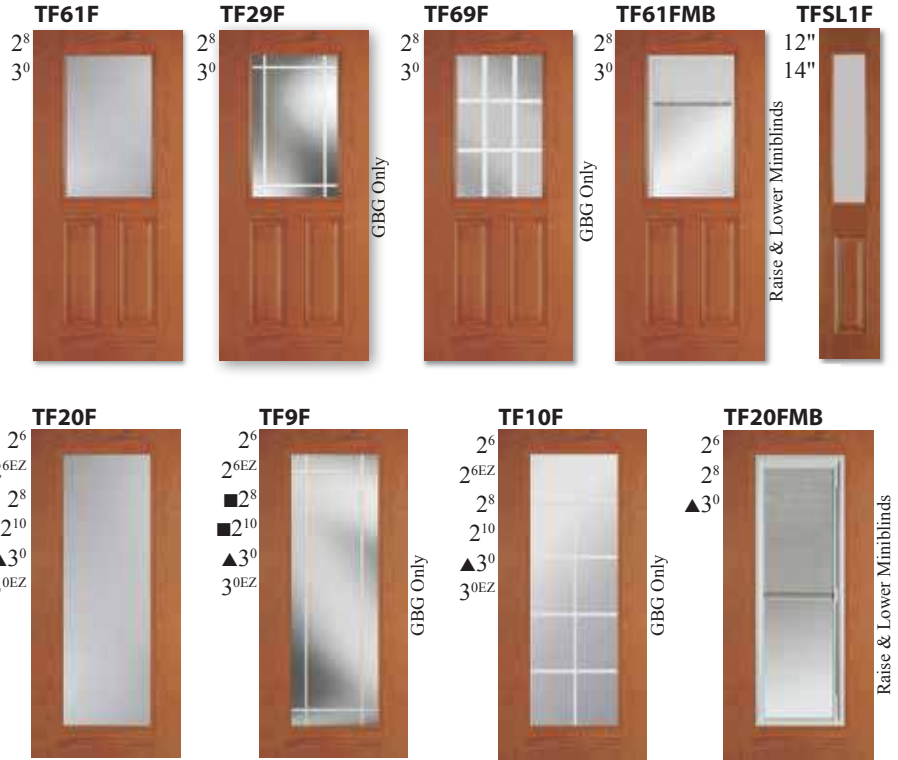

Low-E is now our  
Standard on all  
Commodity glass.  
We also offer a  
high-performance  
Low-E called Low-E  
366. Contact your  
Codel Rep. for more  
information.

## Grids Between Glass (GBG)

Grids Between Glass (GBG) are flat bars between the glass that are inserted at the time the glass is made, showing the grid but leaving a smooth glass surface for easy cleaning.



Color samples are reproduced as close as possible, actual color may vary.

# Simulated Divided Lites (SDL)

Simulated Divided Lite (SDL) doors are created by installing SDL bars on the face of the glass in the door. These bars are applied to both sides of the glass to create the look of a true divided lite while maintaining the energy efficiency value of a single lite.



SDL Bar Profile

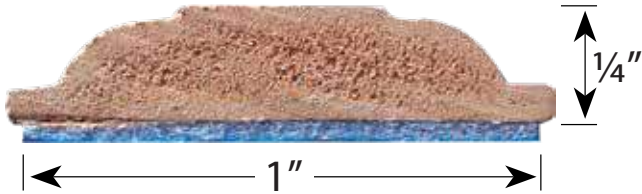

- Available in 6/8 & 8/0 Heights
- Extended Leadtime Required
- No Finishing Available on Traditional SDL Doors

## 6/8 & 8/0 Flush-Glazed Simulated Divided Lites (SDL)

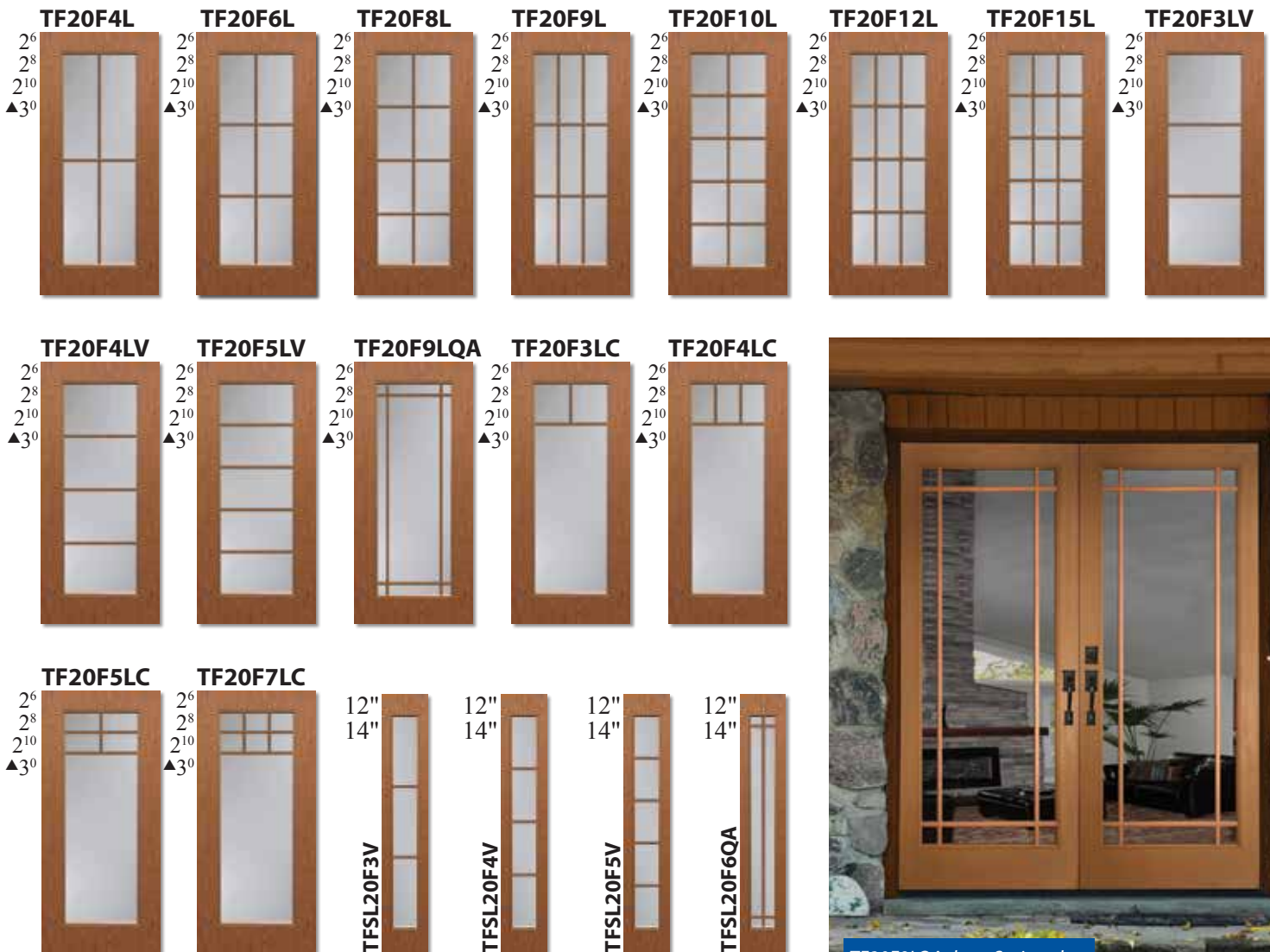

(Sidelites Not Available in 8/0.)



TF20F9LQA door. Stain color shown is not Codel Coatings.



FG20D (x2) doors. Stain color shown is not Codel Coatings.

*Fir Grain Fiberglass*

# Direct Glazed Contemporary

Our Fir Grain Direct Glazed Contemporary FG20D features glass that is directly glazed into the door to create a seamless blend between the glass and door. The large glass pane allows the most scenery and natural light into your home. The FG20D has a traditional Craftsman sticking.

6/8  
2<sup>6</sup>  
2<sup>8</sup>  
3<sup>0</sup>  
  
8/0  
2<sup>6</sup>  
2<sup>8</sup>  
3<sup>0</sup>



FG20D 6<sup>8</sup> & 8<sup>0</sup>

**Also available in Smooth Fiberglass!  
(see pages 36-37)**



20D Sticking



FG20D (x2) doors. Stain color shown is not Codel Coatings.

# CODEL DOORS

## Fir Grain Textured Fiberglass Collection



FG1PSHK door. Stain color shown is not Codel Coatings.

### Key Code Chart

GBG ..... Available w/Grids Between Glass

LE ..... Available w/Low-E Glass

● ..... Available in 7<sup>0</sup> Height

▲ ..... Available in 8<sup>0</sup> Height

■ ..... Available w/Extended Leadtime

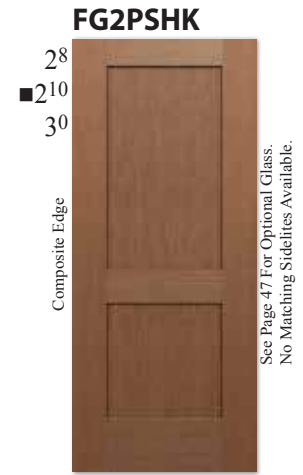

See Page 47 For Optional Glass.  
No Matching Sidelites Available.



See Pages 48-49 For Optional Glass.  
No Matching Sidelites Available.



See Page 27 For Optional Craftsman Shelf,  
Optional Glass and Sidelite Options.



See Pages 50-51 For Optional Glass.  
No Matching Sidelites Available.



Choose one of 2 factory-applied stain colors specially formulated for our Fir Grain Textured Fiberglass doors & sidelites. (Optional)



Ginger

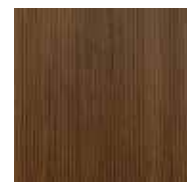

Clove

Color samples are reproduced as close as possible, actual color may vary.

# 2-Panel Premium Shaker Fiberglass Door Collection

(Available in Smooth Fiberglass and Fir Grain Fiberglass)

## 2-Panel Premium Shakers

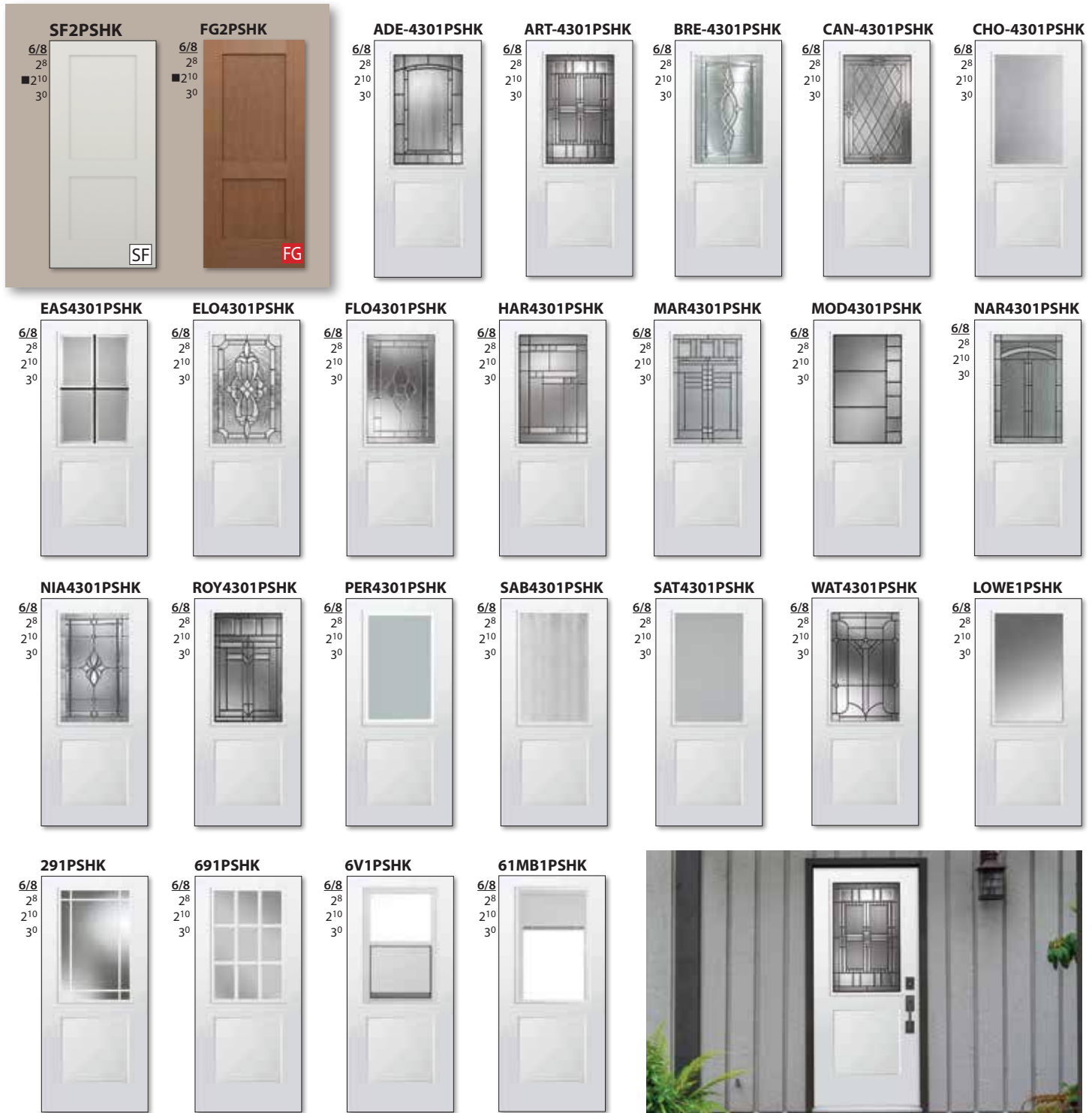

SF Smooth Fiberglass FG Fir Grain Textured



ART-4301PSHK door with Codel Coatings Bright paint.

## Optional Fir Stain and Paint Colors

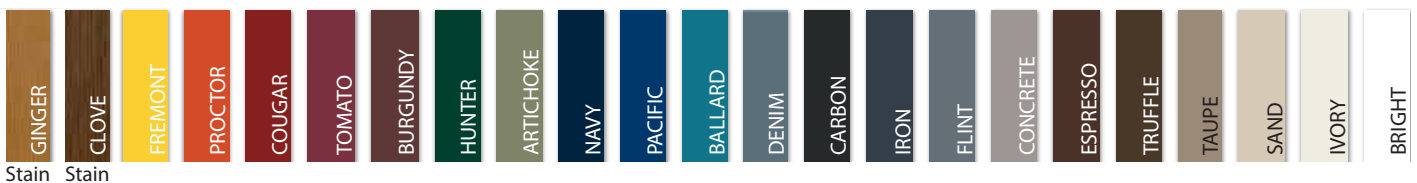

Color samples are reproduced as close as possible, actual color may vary. See back cover for larger swatches.

# One Door Style, Four Options

(Available in Smooth Fiberglass and Fir Grain Fiberglass)

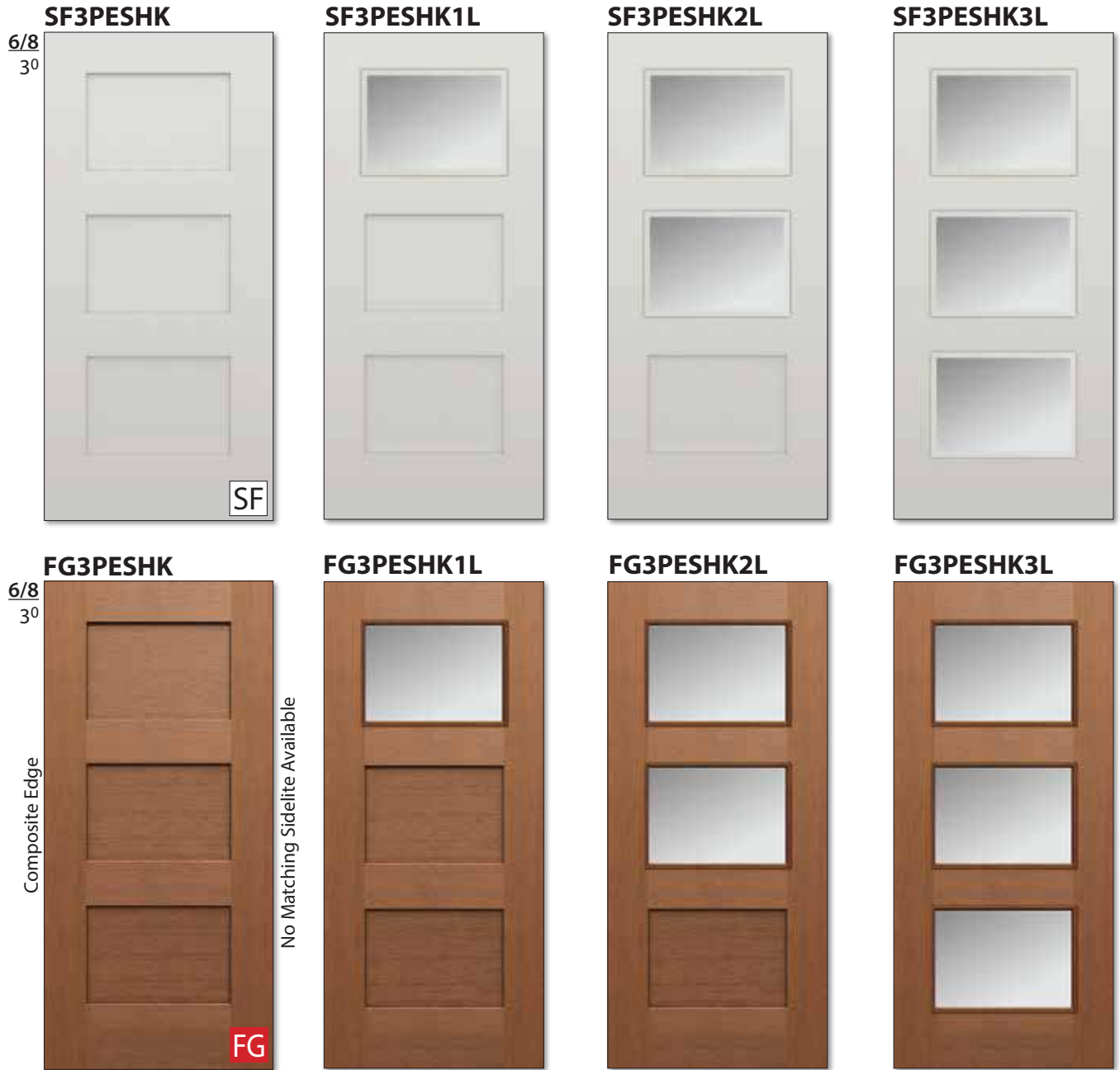

SF Smooth Fiberglass FG Fir Grain Textured

## Optional Fir Stain and Paint Colors

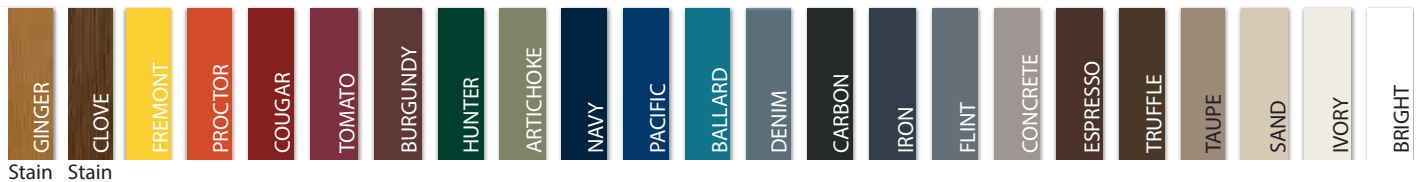

Color samples are reproduced as close as possible, actual color may vary. See back cover for larger swatches.



## Glass Options (Glass size: 22" x 15-1/4")



Low-E



Sable



Satin Etch

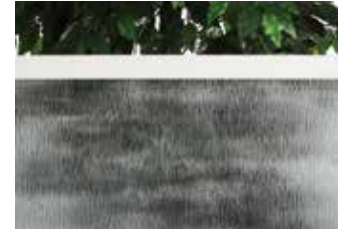

Chord



Adelaide

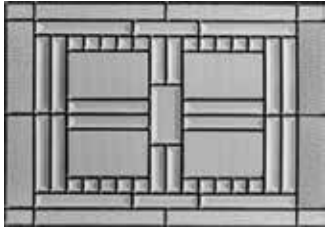

Artisan



Harlow

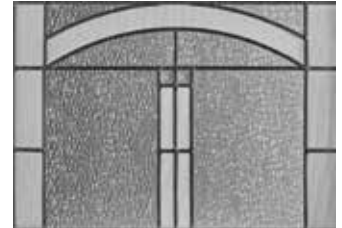

Narrows

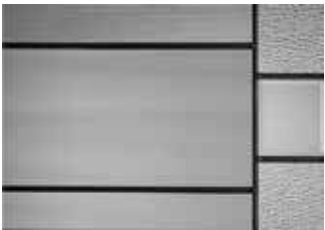

Modena

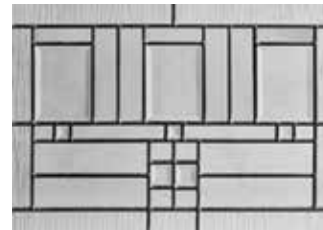

Maren



SF3PSHK2LMAR door. Paint color shown is not Codel Coatings.

# One Door Style, Six Options

(Available in Smooth Fiberglass and Fir Grain Fiberglass)



SF Smooth Fiberglass FG Fir Grain Textured

## Glass Options (Glass size: 22" x 8")



Low-E



Sable



Satin Etch



Chord

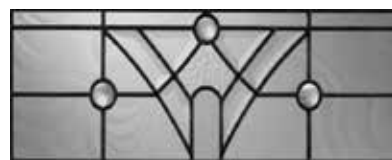

Waterton



SF5PSHK door with (2) Sable individual decorative glass panels. Paint color shown is not Codel Coatings.



FG5PSHK4LWAT door. Stain color shown is not Codel Coatings.



Top panel shows glass insert with Contemporary Low Profile Lite Kit frame.

### Optional Fir Stain and Paint Colors

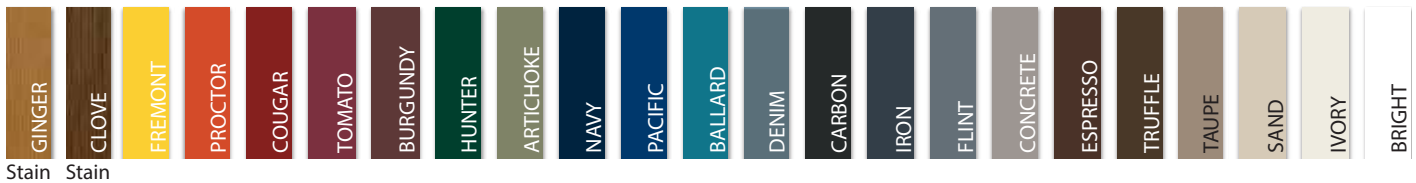

Color samples are reproduced as close as possible, actual color may vary. See back cover for larger swatches.



Rustic CAN-430W door. Stain color shown is not Codel Coatings.

# 6/8 Rustic Fiberglass Collection "Rustic Hardwood" Grain



RUS1PV  
(30)

TF



RUS2PV  
(30)

TF



RUS2PF  
(30)

TF



Standard Lite Kit Frame (Not Wrought Iron)

RUSSL20  
(12" & 14")

TF



Chateau - Wrought Iron Frame, Wrought Iron Grille

CHA-439W  
(30)

TF



Chateau - Wrought Iron Frame, Wrought Iron Grille

CHA-160W  
(12" & 14")

TF



"Knotty Alder" Grain

RUS2PAKA  
(30)

KA



"Knotty Alder" Grain

RUS2PAKASL  
(14")

KA

TF Textured Fiberglass KA Knotty Alder

## 6/8 Rustic Collection

## 8/0 Rustic Collection



CAN-430WVG  
(30)



CAN-430W  
(30)



CAN-160W  
(12" & 14")



RUS1PV80  
(30)



RUS2PV80  
(30, 36)



RUSL280  
(14")



CHA-449W  
(30)

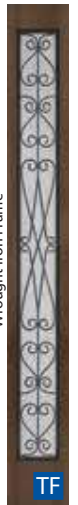

CHA-280  
(14")

# Decorative Options for Rustic Doors

Clavos, hinge straps and speakeasies add an authentic touch to your Rustic door.

## Clavos



Codel offers clavos in 1-1/2" round or 1-1/2" square decorative black metal. Clavos and hinge straps are shipped loose so the customer can apply them on site in the design of their choice. (Clavos and hinge straps come installed on prefinished doors only.)

## Essex Speakeasy

A Speakeasy adds a touch of old-world charm. Sea Spray glass door can open; when closed, Speakeasy seals tightly to prevent air infiltration. (Size: 10" wide x 12" high.)



(Exterior View)



(Interior View)

## Straps & Clavos



1-1/2" Clavos and 18" hinge straps can be added to Rustic doors.

## Lite Kit Frame

The galvanized frame is coated prior to powder coating for additional weather protection.

It features a distinctive iron grille that enhances the old-world styling of our Rustic Door Collection.



**CODEL**  
**DOORS**

# CODEL DOORS

Low-E  
Standard

## Steel Door Collection (6/8 ONLY)



Steel C69 door with Bright paint.

### Key Code Chart

GBG ..... Available w/Grids between Glass

LE ..... Available w/Low-E Glass

■ ..... Extended Leadtime Required

🔥 ..... 20-Min. Fire Rated (\*6-8 Only, 3-0 Max Width.)



## STEEL DOORS

The wood-edge steel door series is a popular choice for new construction as well as remodeling projects.

The versatility and thermal advantages of a wood-edge door are combined with the durability of 24-gauge steel facings. Units are permanently held in place by the adhesion of the polyurethane core.

After assembly, doors are primed for superior corrosion resistance. Wood-edge steel doors are available with a \*20-minute fire rating for all 6'8" doors up to 3'0" wide. (\*Excludes doors w/lite kits.)

### Thermal Performance values established in accordance with the International Energy Conservation Code (IECC) section 102.3

	R value	U value	SHGC value
Steel door unit without Glass	6.25	0.16	0.00
Steel door unit with 1/2 LowE Glass	4.55	0.22	0.16
Steel door unit with Full LowE Glass	3.57	0.28	0.28
Steel door unit with 1/4 Decorative Glass	5.55	0.18	0.07
Steel door unit with 1/2 Decorative Glass	4.16	0.24	0.15
Steel door unit with 3/4 Decorative Glass	4.17	0.24	0.20
Steel door unit with Full Decorative Glass	3.45	0.29	0.27

<p><b>CF</b></p> <p>20 24 26 28 210 30 *36</p> <p>*3-6 is Not Available with Fire Rating</p>	<p><b>C6P</b></p> <p>26 28 210 30</p>	<p><b>C2P</b></p> <p>28 30</p>	<p><b>C4P</b></p> <p>28 30</p>	<p><b>C62</b></p> <p>26 28 210 30</p>	<p><b>C64</b></p> <p>28 210 30</p> <p>Fixed Grid Only</p>	
<p><b>C648CL</b></p> <p>28 210 30</p>	<p><b>CW</b></p> <p>26 28 210 30</p> <p>Fixed Grid Standard</p> <p>GBG</p>	<p><b>CWC</b></p> <p>26 28 210 30</p>	<p><b>C622</b></p> <p>26 28 210 30</p> <p>LE</p>	<p><b>C61</b></p> <p>26 28 210 30</p> <p>LE</p>	<p><b>C29</b></p> <p>26 28 210 30</p> <p>■ GBG &amp; LE</p> <p>GBG only</p>	
<p><b>C69</b></p> <p>26 28 210 30</p> <p>Fixed Grid Standard</p> <p>GBG, GBG &amp; LE / ■ Fixed Grid &amp; LE</p>	<p><b>C6V</b></p> <p>26 28 210 30</p> <p>Vented Glass w/Screen</p> <p>■ LE</p>	<p><b>C61MB</b></p> <p>26 28 210 30</p> <p>Raise &amp; Lower Mini Blind</p> <p>LE 2-8, 2-10 &amp; 3-0 ■ LE 2-6</p>	<p><b>C836</b></p> <p>20 24 26 28 210 30 36</p> <p>8 x 36 Glass</p> <p>LE</p>	<p><b>CF1</b></p> <p>26 28 210 30 36</p> <p>LE</p>	<p><b>C16</b></p> <p>20 24 26 28 210 30 36</p> <p>15 x 15 Glass</p>	
<p><b>CF20</b></p> <p>20 24 26 28 210 30 *36</p> <p>2-0 &amp; 2-4 Glass size is 14x64 3-6 Glass Size is 26 x 64</p> <p>LE, *LE Only</p>	<p><b>CF20V</b></p> <p>28 210 30</p> <p>Vented Glass w/Screen</p> <p>■ LE</p>	<p><b>CF9</b></p> <p>26 28 210 30 36</p> <p>GBG Only 3-6 Glass Size is 22 x 64</p> <p>■ GBG &amp; LE</p>	<p><b>CF10</b></p> <p>20 24 26 28 210 30 36</p> <p>GBG Only 3-6 Glass Size is 22 x 64</p> <p>Fixed Grid Standard 2-0 &amp; 2-4 Glass size is 14x64 3-6 Glass Size is 22 x 64</p> <p>GBG, GBG &amp; LE 2-6 thru 3-6 ■ Fixed Grid &amp; LE, ■ GBG &amp; LE 2-0 &amp; 2-4</p>	<p><b>CF15</b></p> <p>26 28 210 30 36</p> <p>Fixed Grid Standard 3-6 Glass Size is 22 x 64</p> <p>GBG, ■ Fixed Grid &amp; LE, ■ GBG &amp; LE</p>	<p><b>CF20MB</b></p> <p>20 24 26 28 210 30 36</p> <p>Raise &amp; Lower Mini Blinds 2-0 &amp; 2-4 Glass size is 14x64 3-6 Glass Size is 22 x 64</p> <p>LE 2-8 thru 3-6 ■ LE 2-6, (LE N/A 2-0 &amp; 2-4)</p>	
<p><b>C8SDL</b></p> <p>26 28 210 30 36</p> <p>Simulated Divided Lite No Matching Sidelite Available 3-6 Glass Size is 22 x 64</p>	<p><b>CSL1</b></p> <p>12" 14"</p> <p>LE</p>	<p><b>CSL3</b></p> <p>12" 14"</p> <p>Fixed Grid Standard</p> <p>GBG, ■ Fixed Grid &amp; LE</p>	<p><b>CSL20</b></p> <p>12" 14"</p> <p>LE</p>	<p><b>CSL5</b></p> <p>12" 14"</p> <p>Fixed Grid Standard</p> <p>GBG, ■ Fixed Grid &amp; LE</p>	<p><b>CSL1MB</b></p> <p>12" 14"</p> <p>Raise &amp; Lower Mini Blinds</p> <p>■ LE</p>	<p><b>CSL20MB</b></p> <p>12" 14"</p> <p>Raise &amp; Lower Mini Blinds</p> <p>■ LE</p>

# FAST-FRAME™

## Introducing the Ultimate in Adjustable Steel Door Frames

FAST-FRAME'S advanced design adds a new dimension of flexibility and durability to Codel's steel entry door line. FAST-FRAME™ features closure kits with full 1" of adjustability to accommodate almost any variation in wall construction. This easy-to-install, user-friendly, kerfed steel door frame system is applicable to a full range of residential and commercial applications - wood or steel stud construction. FAST-FRAME is engineered to meet the most stringent code requirements, including structural, impact and 90-minute fire ratings.



C690 door with Bright paint.

**Adjustable T-Strike**  
1/4" of adjustment allows for ease of field installations for proper door closure

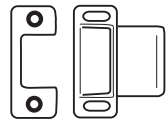

**Closure Span Adjustment Chart**  
Wall Sizes

4 1/2" - 5 1/2"
5 1/2" - 6 1/2"
6 1/2" - 7 1/2"
7 1/2" - 8 1/2"
8 1/2" - 9 1/2"
9 1/2" - 10 1/2"

**Weatherstripping**  
Schlegal foam-filled compression (QEBD500)  
90 Min. Fire Rating

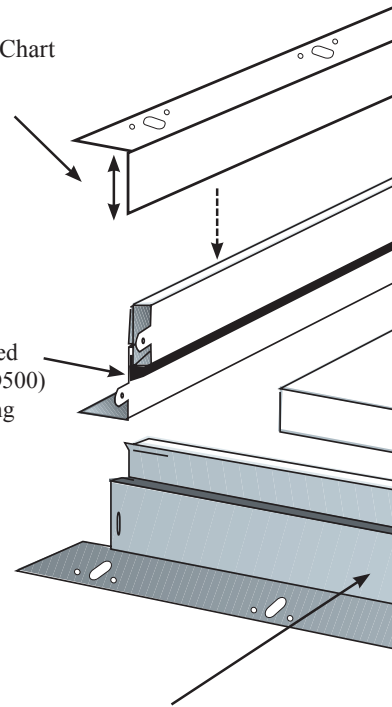

Prime Bright White EG  
Galvanized 20-gauge steel to provide superior corrosion resistance and an optimal surface for painting

### APPLICATIONS

- Multi-Family •Assisted Living •Motel/Hotel •House to Garage •Garage to Exterior



### FIRE LABELS

90 Minute Fire Rating - up to 3'0" x 6'8".

**CLOSURE TEST** In a 90-minute application, the door will close and latch from 18" if the following Fast-Frame components are used:

- QEBD500 Foam-Filled Compression Weatherstripping
- Factory Sweep • Adjustable T-Strike • Factory Supplied Sills



### STRUCTURAL PERFORMANCE AND IMPACT RATING

Design pressure ratings are available for compliance with national, state and local wind load and/or missile requirements. Product approval under the Miami-Dade BCCO NOA or Intertek Testing Services/Warnock Hersey® programs.



## Door Handing

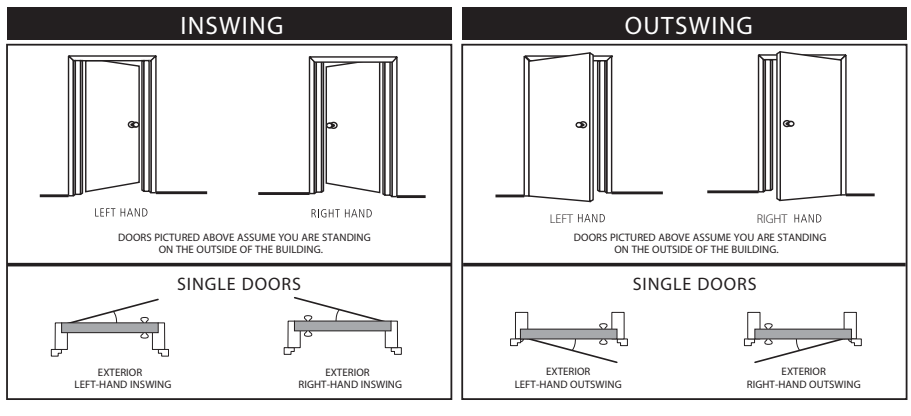

### SILLS

Standard Inswing  
 Thermally broken - 5 5/8" width  
 Optional extenders for larger wall sizes  
 Note: Not for use on outswing applications.



### Handicap (ADA)

Double Slope 4-9/16" & 6-9/16" width



Tile Face 4-1/4" and 6-1/4"



Outer Adjustable Closure  
 20-gauge Steel  
 2 uprights - 1 header

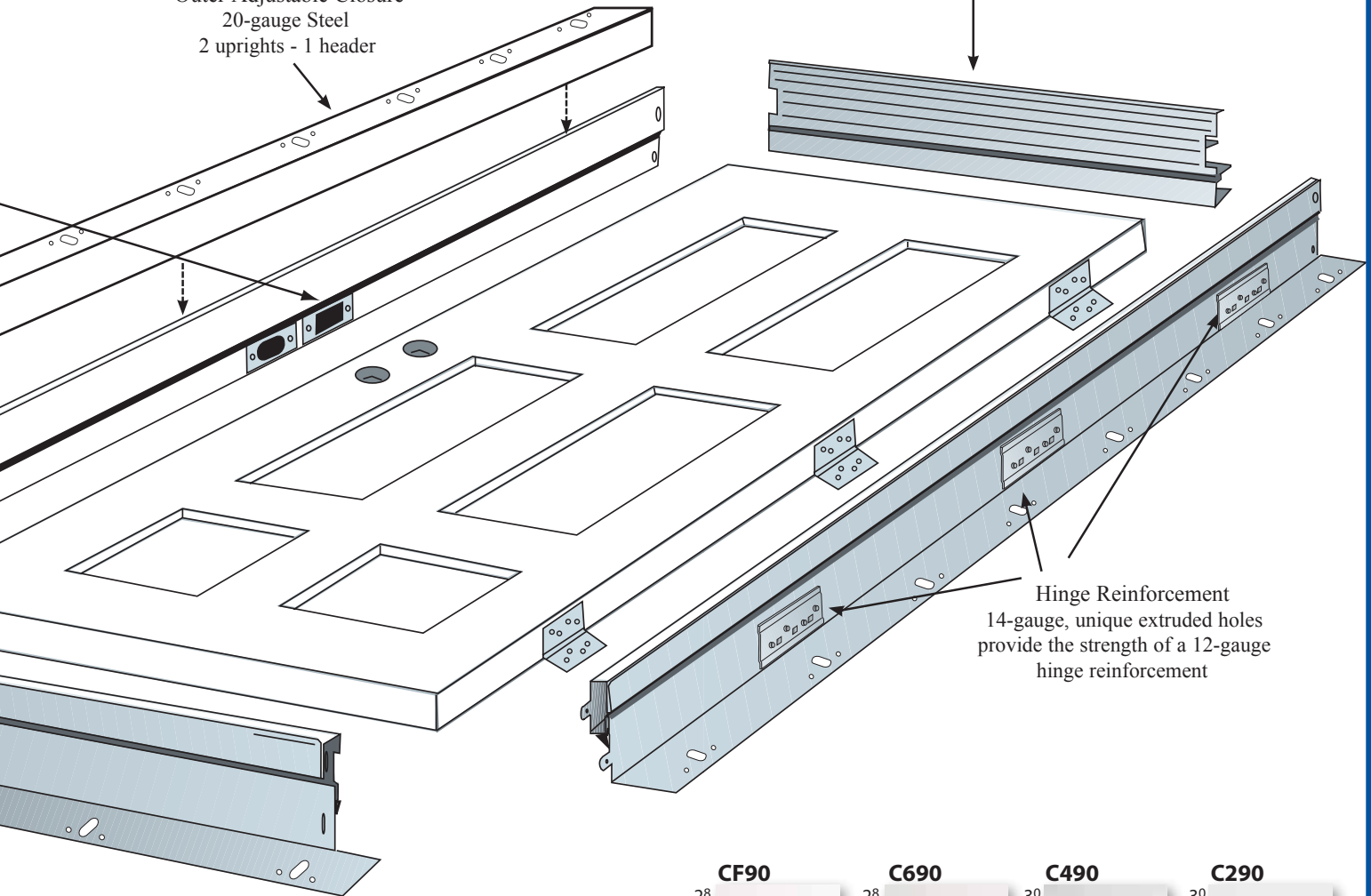

Hinge Reinforcement  
 14-gauge, unique extruded holes provide the strength of a 12-gauge hinge reinforcement

## Prehung Door Sizes

Single Door

Nominal Door Size	Rough Opening Size (wood stud)
Width x Height	Width x Height
2' 8" x 6' 8"	33-1/4" x 81-3/8"
3' 0" x 6' 8"	37-1/4" x 81-3/8"
3' 0" x 7' 0"	37-1/4" x 85-3/8"

-All dimensions shown are for doors with standard inswing sill.  
 Deduct 13/16" for bumper outswing or handicap compliant sill.

■ Extended Leadtime Required. 🔥 90-Minute Fire-Rated.



\*Available in 7/0



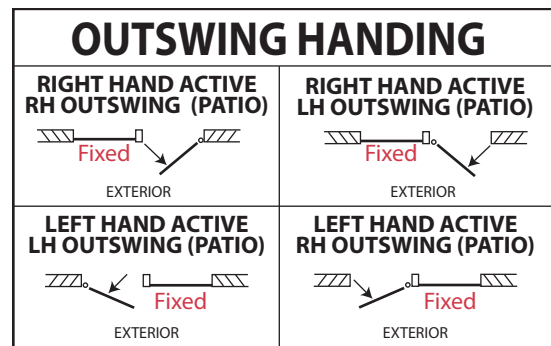
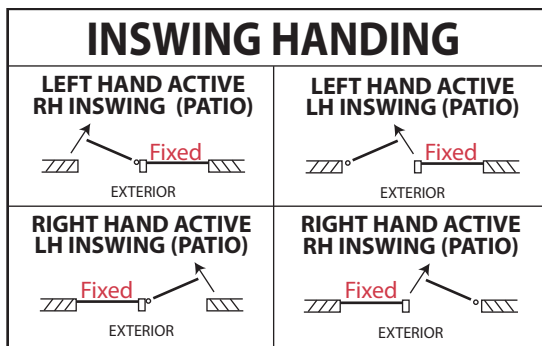

# SINGLE-HINGED INSWING FIBERGLASS PATIO DOOR

The Single-Hinged Inswing Patio door provides the look of a double door, with the functionality of a single door. The “one-door-fixed/one-door-operable” configuration comes standard with a sliding screen, and is perfect for areas where interior space is limited. Available in a variety of sizes ranging from standard to retro-fit (EZ-Fit), the Single-Hinged Inswing Patio door is a great choice for new construction and remodel projects, alike.

*(Outswing option also available with no sliding screen)*



\*Screen not available on outswings.

	Standard 6-8 Patio Sizes (SP)	EZ-Fit (Retro) Patio Sizes (EZP)																																				
<p><b>20F/20</b></p>  <p style="text-align: right;">Low-E Only</p> <p>SF TF</p>	<table border="1"> <thead> <tr> <th>FLUSH-GLAZED SIZES</th> <th>LITE KIT SIZES</th> </tr> </thead> <tbody> <tr> <td><b>SF20FSP</b></td> <td><b>SF20SP</b></td> </tr> <tr> <td>5-0 x 6-8</td> <td>5-0 x 6-8</td> </tr> <tr> <td>5-4 x 6-8</td> <td>5-4 x 6-8</td> </tr> <tr> <td>5-8 x 6-8</td> <td>5-8 x 6-8</td> </tr> <tr> <td>6-0 x 6-8</td> <td>6-0 x 6-8</td> </tr> <tr> <td><b>TF20FSP</b></td> <td><b>TF20SP</b></td> </tr> <tr> <td>5-0 x 6-8</td> <td>5-0 x 6-8</td> </tr> <tr> <td>5-4 x 6-8</td> <td>5-4 x 6-8</td> </tr> <tr> <td>5-8 x 6-8</td> <td>5-8 x 6-8</td> </tr> <tr> <td>6-0 x 6-8</td> <td>6-0 x 6-8</td> </tr> </tbody> </table>	FLUSH-GLAZED SIZES	LITE KIT SIZES	<b>SF20FSP</b>	<b>SF20SP</b>	5-0 x 6-8	5-0 x 6-8	5-4 x 6-8	5-4 x 6-8	5-8 x 6-8	5-8 x 6-8	6-0 x 6-8	6-0 x 6-8	<b>TF20FSP</b>	<b>TF20SP</b>	5-0 x 6-8	5-0 x 6-8	5-4 x 6-8	5-4 x 6-8	5-8 x 6-8	5-8 x 6-8	6-0 x 6-8	6-0 x 6-8	<table border="1"> <thead> <tr> <th>FLUSH-GLAZED SIZES</th> <th>LITE KIT SIZES</th> </tr> </thead> <tbody> <tr> <td><b>SF20FEZP</b></td> <td><b>SF20EZP</b></td> </tr> <tr> <td>5-0 x EZ</td> <td>5-0 x EZ</td> </tr> <tr> <td>6-0 x EZ</td> <td>6-0 x EZ</td> </tr> <tr> <td><b>TF20FEZP</b></td> <td><b>TF20EZP</b></td> </tr> <tr> <td>5-0 x EZ</td> <td>6-0 x EZ</td> </tr> <tr> <td>6-0 x EZ</td> <td></td> </tr> </tbody> </table>	FLUSH-GLAZED SIZES	LITE KIT SIZES	<b>SF20FEZP</b>	<b>SF20EZP</b>	5-0 x EZ	5-0 x EZ	6-0 x EZ	6-0 x EZ	<b>TF20FEZP</b>	<b>TF20EZP</b>	5-0 x EZ	6-0 x EZ	6-0 x EZ	
FLUSH-GLAZED SIZES	LITE KIT SIZES																																					
<b>SF20FSP</b>	<b>SF20SP</b>																																					
5-0 x 6-8	5-0 x 6-8																																					
5-4 x 6-8	5-4 x 6-8																																					
5-8 x 6-8	5-8 x 6-8																																					
6-0 x 6-8	6-0 x 6-8																																					
<b>TF20FSP</b>	<b>TF20SP</b>																																					
5-0 x 6-8	5-0 x 6-8																																					
5-4 x 6-8	5-4 x 6-8																																					
5-8 x 6-8	5-8 x 6-8																																					
6-0 x 6-8	6-0 x 6-8																																					
FLUSH-GLAZED SIZES	LITE KIT SIZES																																					
<b>SF20FEZP</b>	<b>SF20EZP</b>																																					
5-0 x EZ	5-0 x EZ																																					
6-0 x EZ	6-0 x EZ																																					
<b>TF20FEZP</b>	<b>TF20EZP</b>																																					
5-0 x EZ	6-0 x EZ																																					
6-0 x EZ																																						
<p><b>10F/10</b></p>  <p style="text-align: right;">10-Lite Fixed or GBG</p> <p>SF TF</p>	<table border="1"> <thead> <tr> <th>FLUSH-GLAZED SIZES</th> <th>LITE KIT SIZES</th> </tr> </thead> <tbody> <tr> <td><b>SF10FSP</b></td> <td><b>SF10SP</b></td> </tr> <tr> <td>5-0 x 6-8</td> <td>5-0 x 6-8</td> </tr> <tr> <td>5-4 x 6-8</td> <td>5-4 x 6-8</td> </tr> <tr> <td>5-8 x 6-8</td> <td>5-8 x 6-8</td> </tr> <tr> <td>6-0 x 6-8</td> <td>6-0 x 6-8</td> </tr> <tr> <td><b>TF10FSP</b></td> <td><b>TF10SP</b></td> </tr> <tr> <td>5-0 x 6-8</td> <td>5-0 x 6-8</td> </tr> <tr> <td>5-4 x 6-8</td> <td>5-4 x 6-8</td> </tr> <tr> <td>5-8 x 6-8</td> <td>5-8 x 6-8</td> </tr> <tr> <td>6-0 x 6-8</td> <td>6-0 x 6-8</td> </tr> </tbody> </table>	FLUSH-GLAZED SIZES	LITE KIT SIZES	<b>SF10FSP</b>	<b>SF10SP</b>	5-0 x 6-8	5-0 x 6-8	5-4 x 6-8	5-4 x 6-8	5-8 x 6-8	5-8 x 6-8	6-0 x 6-8	6-0 x 6-8	<b>TF10FSP</b>	<b>TF10SP</b>	5-0 x 6-8	5-0 x 6-8	5-4 x 6-8	5-4 x 6-8	5-8 x 6-8	5-8 x 6-8	6-0 x 6-8	6-0 x 6-8	<table border="1"> <thead> <tr> <th>FLUSH-GLAZED SIZES</th> <th>LITE KIT SIZES</th> </tr> </thead> <tbody> <tr> <td><b>SF10FEZP</b></td> <td><b>SF10EZP</b></td> </tr> <tr> <td>5-0 x EZ</td> <td>5-0 x EZ</td> </tr> <tr> <td>6-0 x EZ</td> <td>6-0 x EZ</td> </tr> <tr> <td><b>TF10FEZP</b></td> <td><b>TF10EZP</b></td> </tr> <tr> <td>5-0 x EZ</td> <td>6-0 x EZ</td> </tr> <tr> <td>6-0 x EZ</td> <td></td> </tr> </tbody> </table>	FLUSH-GLAZED SIZES	LITE KIT SIZES	<b>SF10FEZP</b>	<b>SF10EZP</b>	5-0 x EZ	5-0 x EZ	6-0 x EZ	6-0 x EZ	<b>TF10FEZP</b>	<b>TF10EZP</b>	5-0 x EZ	6-0 x EZ	6-0 x EZ	
FLUSH-GLAZED SIZES	LITE KIT SIZES																																					
<b>SF10FSP</b>	<b>SF10SP</b>																																					
5-0 x 6-8	5-0 x 6-8																																					
5-4 x 6-8	5-4 x 6-8																																					
5-8 x 6-8	5-8 x 6-8																																					
6-0 x 6-8	6-0 x 6-8																																					
<b>TF10FSP</b>	<b>TF10SP</b>																																					
5-0 x 6-8	5-0 x 6-8																																					
5-4 x 6-8	5-4 x 6-8																																					
5-8 x 6-8	5-8 x 6-8																																					
6-0 x 6-8	6-0 x 6-8																																					
FLUSH-GLAZED SIZES	LITE KIT SIZES																																					
<b>SF10FEZP</b>	<b>SF10EZP</b>																																					
5-0 x EZ	5-0 x EZ																																					
6-0 x EZ	6-0 x EZ																																					
<b>TF10FEZP</b>	<b>TF10EZP</b>																																					
5-0 x EZ	6-0 x EZ																																					
6-0 x EZ																																						
<p><b>9F/9</b></p>  <p style="text-align: right;">9-Lite Marginal, GBG Only</p> <p>SF TF</p>	<table border="1"> <thead> <tr> <th>FLUSH-GLAZED SIZES</th> <th>LITE KIT SIZES</th> </tr> </thead> <tbody> <tr> <td><b>SF9FSP</b></td> <td><b>SF9SP</b></td> </tr> <tr> <td>5-0 x 6-8</td> <td>5-0 x 6-8</td> </tr> <tr> <td>5-4 x 6-8</td> <td>5-4 x 6-8</td> </tr> <tr> <td>5-8 x 6-8</td> <td>5-8 x 6-8</td> </tr> <tr> <td>6-0 x 6-8</td> <td>6-0 x 6-8</td> </tr> <tr> <td><b>TF9FSP</b></td> <td><b>TF9SP</b></td> </tr> <tr> <td>5-0 x 6-8</td> <td>5-0 x 6-8</td> </tr> <tr> <td>5-4 x 6-8</td> <td>5-4 x 6-8</td> </tr> <tr> <td>5-8 x 6-8</td> <td>5-8 x 6-8</td> </tr> <tr> <td>6-0 x 6-8</td> <td>6-0 x 6-8</td> </tr> </tbody> </table>	FLUSH-GLAZED SIZES	LITE KIT SIZES	<b>SF9FSP</b>	<b>SF9SP</b>	5-0 x 6-8	5-0 x 6-8	5-4 x 6-8	5-4 x 6-8	5-8 x 6-8	5-8 x 6-8	6-0 x 6-8	6-0 x 6-8	<b>TF9FSP</b>	<b>TF9SP</b>	5-0 x 6-8	5-0 x 6-8	5-4 x 6-8	5-4 x 6-8	5-8 x 6-8	5-8 x 6-8	6-0 x 6-8	6-0 x 6-8	<table border="1"> <thead> <tr> <th>FLUSH-GLAZED SIZES</th> <th>LITE KIT SIZES</th> </tr> </thead> <tbody> <tr> <td><b>SF9FEZP</b></td> <td><b>SF9EZP</b></td> </tr> <tr> <td>5-0 x EZ</td> <td>5-0 x EZ</td> </tr> <tr> <td>6-0 x EZ</td> <td>6-0 x EZ</td> </tr> <tr> <td><b>TF9FEZP</b></td> <td><b>TF9EZP</b></td> </tr> <tr> <td>5-0 x EZ</td> <td>6-0 x EZ</td> </tr> <tr> <td>6-0 x EZ</td> <td></td> </tr> </tbody> </table>	FLUSH-GLAZED SIZES	LITE KIT SIZES	<b>SF9FEZP</b>	<b>SF9EZP</b>	5-0 x EZ	5-0 x EZ	6-0 x EZ	6-0 x EZ	<b>TF9FEZP</b>	<b>TF9EZP</b>	5-0 x EZ	6-0 x EZ	6-0 x EZ	
FLUSH-GLAZED SIZES	LITE KIT SIZES																																					
<b>SF9FSP</b>	<b>SF9SP</b>																																					
5-0 x 6-8	5-0 x 6-8																																					
5-4 x 6-8	5-4 x 6-8																																					
5-8 x 6-8	5-8 x 6-8																																					
6-0 x 6-8	6-0 x 6-8																																					
<b>TF9FSP</b>	<b>TF9SP</b>																																					
5-0 x 6-8	5-0 x 6-8																																					
5-4 x 6-8	5-4 x 6-8																																					
5-8 x 6-8	5-8 x 6-8																																					
6-0 x 6-8	6-0 x 6-8																																					
FLUSH-GLAZED SIZES	LITE KIT SIZES																																					
<b>SF9FEZP</b>	<b>SF9EZP</b>																																					
5-0 x EZ	5-0 x EZ																																					
6-0 x EZ	6-0 x EZ																																					
<b>TF9FEZP</b>	<b>TF9EZP</b>																																					
5-0 x EZ	6-0 x EZ																																					
6-0 x EZ																																						
<p><b>20FMB/20MB</b></p>  <p style="text-align: right;">Miniblinds</p> <p>SF TF</p>	<table border="1"> <thead> <tr> <th>FLUSH-GLAZED SIZES</th> <th>LITE KIT SIZES</th> </tr> </thead> <tbody> <tr> <td><b>SF20FMBSP</b></td> <td><b>SF20MBSP</b></td> </tr> <tr> <td>5-0 x 6-8</td> <td>5-0 x 6-8</td> </tr> <tr> <td>5-4 x 6-8</td> <td>5-4 x 6-8</td> </tr> <tr> <td>6-0 x 6-8</td> <td>5-8 x 6-8</td> </tr> <tr> <td></td> <td>6-0 x 6-8</td> </tr> <tr> <td><b>TF20FMBSP</b></td> <td><b>TF20MBSP</b></td> </tr> <tr> <td>5-0 x 6-8</td> <td>5-0 x 6-8</td> </tr> <tr> <td>5-4 x 6-8</td> <td>5-4 x 6-8</td> </tr> <tr> <td>6-0 x 6-8</td> <td>5-8 x 6-8</td> </tr> <tr> <td></td> <td>6-0 x 6-8</td> </tr> </tbody> </table>	FLUSH-GLAZED SIZES	LITE KIT SIZES	<b>SF20FMBSP</b>	<b>SF20MBSP</b>	5-0 x 6-8	5-0 x 6-8	5-4 x 6-8	5-4 x 6-8	6-0 x 6-8	5-8 x 6-8		6-0 x 6-8	<b>TF20FMBSP</b>	<b>TF20MBSP</b>	5-0 x 6-8	5-0 x 6-8	5-4 x 6-8	5-4 x 6-8	6-0 x 6-8	5-8 x 6-8		6-0 x 6-8	<table border="1"> <thead> <tr> <th>LITE KIT SIZES (ONLY)</th> </tr> </thead> <tbody> <tr> <td><b>SF20MBEZP</b></td> </tr> <tr> <td>5-0 x EZ</td> </tr> <tr> <td>6-0 x EZ</td> </tr> <tr> <td><b>TF20MBEZP</b></td> </tr> <tr> <td>6-0 x EZ</td> </tr> </tbody> </table>	LITE KIT SIZES (ONLY)	<b>SF20MBEZP</b>	5-0 x EZ	6-0 x EZ	<b>TF20MBEZP</b>	6-0 x EZ								
FLUSH-GLAZED SIZES	LITE KIT SIZES																																					
<b>SF20FMBSP</b>	<b>SF20MBSP</b>																																					
5-0 x 6-8	5-0 x 6-8																																					
5-4 x 6-8	5-4 x 6-8																																					
6-0 x 6-8	5-8 x 6-8																																					
	6-0 x 6-8																																					
<b>TF20FMBSP</b>	<b>TF20MBSP</b>																																					
5-0 x 6-8	5-0 x 6-8																																					
5-4 x 6-8	5-4 x 6-8																																					
6-0 x 6-8	5-8 x 6-8																																					
	6-0 x 6-8																																					
LITE KIT SIZES (ONLY)																																						
<b>SF20MBEZP</b>																																						
5-0 x EZ																																						
6-0 x EZ																																						
<b>TF20MBEZP</b>																																						
6-0 x EZ																																						
<p><b>20V</b></p>  <p style="text-align: right;">Vented w/Screen Bottom moves up and down. Top does not. Lite Kit Available in White Only</p> <p>SF TF</p>	<table border="1"> <thead> <tr> <th>LITE KIT SIZES</th> </tr> </thead> <tbody> <tr> <td><b>SF20VSP</b></td> </tr> <tr> <td>5-0 x 6-8</td> </tr> <tr> <td>5-4 x 6-8</td> </tr> <tr> <td>5-8 x 6-8</td> </tr> <tr> <td>6-0 x 6-8</td> </tr> <tr> <td><b>TF20VSP</b></td> </tr> <tr> <td>5-0 x 6-8</td> </tr> <tr> <td>5-4 x 6-8</td> </tr> <tr> <td>5-8 x 6-8</td> </tr> <tr> <td>6-0 x 6-8</td> </tr> </tbody> </table>	LITE KIT SIZES	<b>SF20VSP</b>	5-0 x 6-8	5-4 x 6-8	5-8 x 6-8	6-0 x 6-8	<b>TF20VSP</b>	5-0 x 6-8	5-4 x 6-8	5-8 x 6-8	6-0 x 6-8	<table border="1"> <thead> <tr> <th>LITE KIT SIZES (ONLY)</th> </tr> </thead> <tbody> <tr> <td><b>SF20VEZP</b></td> </tr> <tr> <td>6-0 x EZ</td> </tr> <tr> <td><b>TF20VEZP</b></td> </tr> <tr> <td>6-0 x EZ</td> </tr> </tbody> </table>	LITE KIT SIZES (ONLY)	<b>SF20VEZP</b>	6-0 x EZ	<b>TF20VEZP</b>	6-0 x EZ																				
LITE KIT SIZES																																						
<b>SF20VSP</b>																																						
5-0 x 6-8																																						
5-4 x 6-8																																						
5-8 x 6-8																																						
6-0 x 6-8																																						
<b>TF20VSP</b>																																						
5-0 x 6-8																																						
5-4 x 6-8																																						
5-8 x 6-8																																						
6-0 x 6-8																																						
LITE KIT SIZES (ONLY)																																						
<b>SF20VEZP</b>																																						
6-0 x EZ																																						
<b>TF20VEZP</b>																																						
6-0 x EZ																																						
<p><b>CODEL DOORS</b></p>	<table border="1"> <thead> <tr> <th></th> <th>NET UNIT WIDTH</th> <th>INSWING ADJ. SILL</th> <th>OUTSWING BUMPER SILL</th> </tr> </thead> <tbody> <tr> <td>5-0 x 6-8</td> <td>62-3/4"</td> <td>81-3/4"</td> <td>80-1/2"</td> </tr> <tr> <td>5-4 x 6-8</td> <td>66-3/4"</td> <td>81-3/4"</td> <td>80-1/2"</td> </tr> <tr> <td>5-8 x 6-8</td> <td>70-3/4"</td> <td>81-3/4"</td> <td>80-1/2"</td> </tr> <tr> <td>6-0 x 6-8</td> <td>74-3/4"</td> <td>81-3/4"</td> <td>80-1/2"</td> </tr> </tbody> </table> <p><small>*Screen not available on outswings.</small></p>		NET UNIT WIDTH	INSWING ADJ. SILL	OUTSWING BUMPER SILL	5-0 x 6-8	62-3/4"	81-3/4"	80-1/2"	5-4 x 6-8	66-3/4"	81-3/4"	80-1/2"	5-8 x 6-8	70-3/4"	81-3/4"	80-1/2"	6-0 x 6-8	74-3/4"	81-3/4"	80-1/2"	<table border="1"> <thead> <tr> <th></th> <th>NET UNIT WIDTH</th> <th>INSWING ADJ. SILL</th> <th>OUTSWING BUMPER SILL</th> </tr> </thead> <tbody> <tr> <td>5-0 x EZ-FIT</td> <td>59-3/4"</td> <td>79-1/2"</td> <td>78-3/4"</td> </tr> <tr> <td>6-0 x EZ-FIT</td> <td>71-3/4"</td> <td>79-1/2"</td> <td>78-3/4"</td> </tr> </tbody> </table> <p><small>*Screen not available on outswings.</small></p>		NET UNIT WIDTH	INSWING ADJ. SILL	OUTSWING BUMPER SILL	5-0 x EZ-FIT	59-3/4"	79-1/2"	78-3/4"	6-0 x EZ-FIT	71-3/4"	79-1/2"	78-3/4"				
	NET UNIT WIDTH	INSWING ADJ. SILL	OUTSWING BUMPER SILL																																			
5-0 x 6-8	62-3/4"	81-3/4"	80-1/2"																																			
5-4 x 6-8	66-3/4"	81-3/4"	80-1/2"																																			
5-8 x 6-8	70-3/4"	81-3/4"	80-1/2"																																			
6-0 x 6-8	74-3/4"	81-3/4"	80-1/2"																																			
	NET UNIT WIDTH	INSWING ADJ. SILL	OUTSWING BUMPER SILL																																			
5-0 x EZ-FIT	59-3/4"	79-1/2"	78-3/4"																																			
6-0 x EZ-FIT	71-3/4"	79-1/2"	78-3/4"																																			

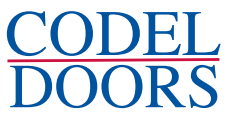

SF20F Double w/Right Opening and sidelites. Carbon Codel Coatings paint.

# TRADITIONAL PATIO DOORS

The Traditional Patio Door is our standard double door but focused on your patio. We also added our maximum width options for each size, to allow you to dream. Available in a variety of sizes in both Smooth and Textured fiberglass, ranging from your standard double door, to adding a sidelite or non-active door as a sidelite. The Traditional Patio Door is a great choice for new construction and remodel projects, and to match your CODEL entry door.

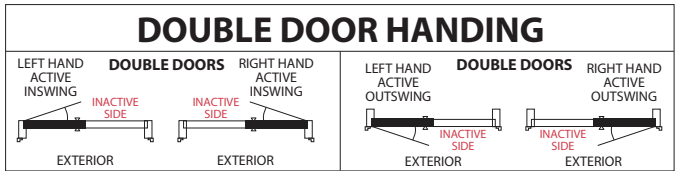

20F/20 Double



Clear/Low-E

20F/20 Double w/Left Non-Opening



Clear/Low-E

Max Width 9'0"

20F/20 Double w/Right Non-Opening



Clear/Low-E

Max Width 9'0"

20F/20 Double w/Left & Right Non-Opening



Clear/Low-E

Max Width 12'0"

9F/9



9 Lite Marginal, GBG Only

9F/9 Double w/Left Non-Opening



9 Lite Marginal, GBG Only

Max Width 9'0"

9F/9 Double w/Right Non-Opening



9 Lite Marginal, GBG Only

Max Width 9'0"

9F/9 Double w/Left & Right Non-Opening



9 Lite Marginal, GBG Only

Max Width 12'0"

10F/10



10 Lite Fixed or GBG



10F/10 Double w/Left Non-Opening



10 Lite Fixed or GBG



Max Width 9'0"

10F/10 Double w/Right Non-Opening



10 Lite Fixed or GBG



Max Width 9'0"

10F/10 Double w/Left & Right Non-Opening



10 Lite Fixed or GBG



Max Width 12'0"

20FMB/20MB



Lite Kit

Raise & Lower Mini Blinds



20FMB/20MB Double w/Left Non-Opening



Raise & Lower Mini Blinds



Max Width 9'0"

20FMB/20MB Double w/Right Non-Opening



Raise & Lower Mini Blinds



Max Width 9'0"

20FMB/20MB Double w/Left & Right Non-Opening



Raise & Lower Mini Blinds



Max Width 12'0"

20V



Vented w/Screen  
Lite Kit Available in White Only



20V Double w/Left Non-Opening



Vented w/Screen  
Lite Kit Available in White Only



Max Width 9'0"

20V Double w/Right Non-Opening



Vented w/Screen  
Lite Kit Available in White Only



Max Width 9'0"

20V Double w/Left & Right Non-Opening



Vented w/Screen  
Lite Kit Available in White Only



Max Width 12'0"

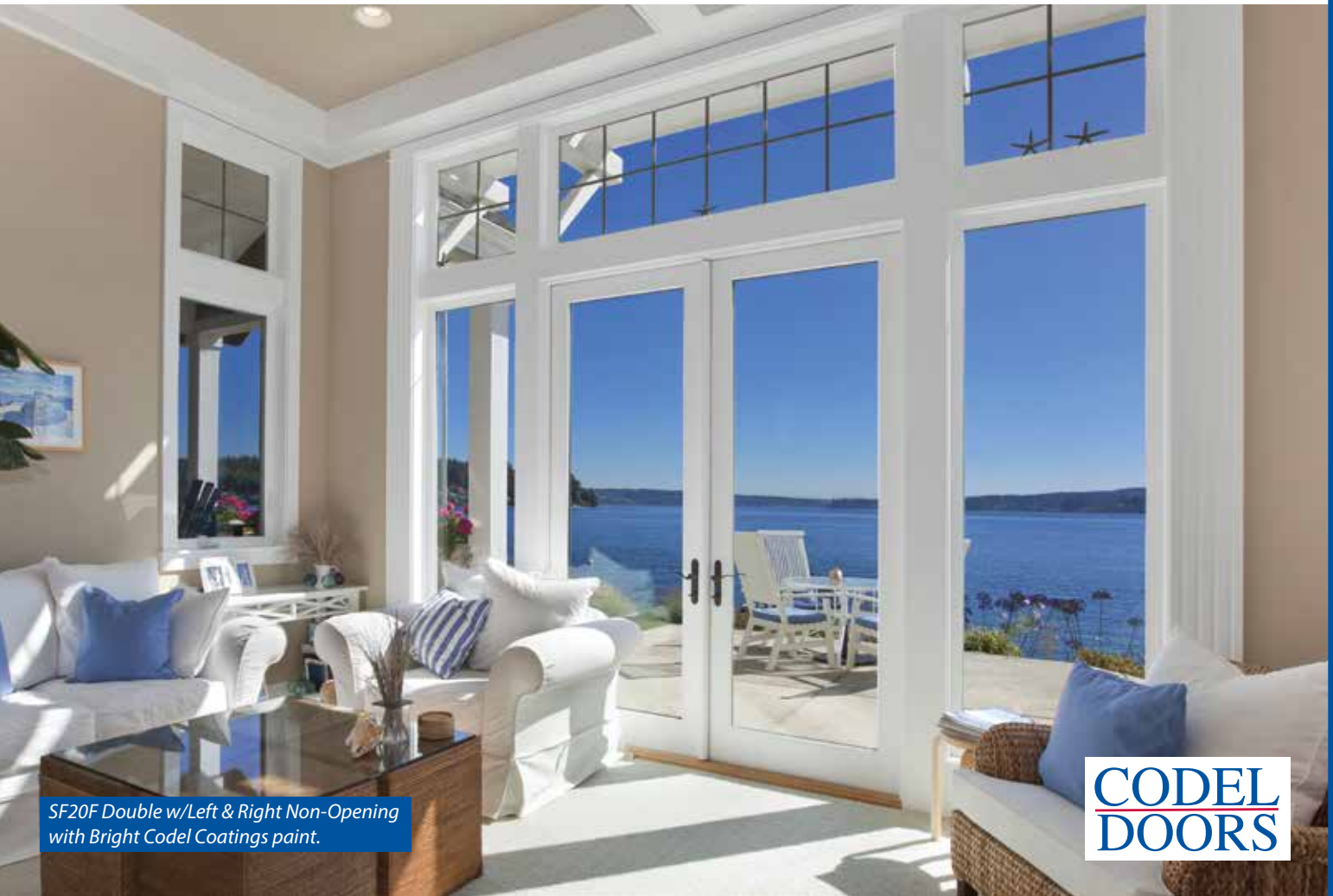

SF20F Double w/Left & Right Non-Opening with Bright Codel Coatings paint.





**"EZ-Fit" Double Doors  
Net UNIT Sizes**

	NET UNIT WIDTH	INSWING ADJ. SILL	OUTSWING BUMPER SILL
5-0 x EZ-FIT	59-3/4"	79-1/2"	78-3/4"
6-0 x EZ-FIT	71-3/4"	79-1/2"	78-3/4"



**6-8 EZ-Fit "Retro-Sized"  
Double Doors w/Astragal (EZ) (both doors open)**

GBG Available w/Grids Between Glass

LE Available w/Low-E Glass

■ Extended Leadtime Required

20F/20



Low-E Only

SF  
TF

FLUSH-GLAZED SIZES	LITE KIT SIZES
<b>SF20FEZ</b> 5-0 x EZ 6-0 x EZ	<b>SF20EZ</b> 5-0 x EZ 6-0 x EZ
<b>TF20FEZ</b> 5-0 x EZ 6-0 x EZ	<b>TF20EZ</b> 6-0 x EZ

10F/10



10 Lite Fixed or GBG

SF  
TF

FLUSH-GLAZED SIZES	LITE KIT SIZES
<b>SF10FEZ</b> 5-0 x EZ 6-0 x EZ	<b>SF10EZ</b> 5-0 x EZ 6-0 x EZ
<b>TF10FEZ</b> 5-0 x EZ 6-0 x EZ	<b>TF10EZ</b> 6-0 x EZ

9F/9



9 Lite Marginal, GBG Only

SF  
TF

FLUSH-GLAZED SIZES	LITE KIT SIZES
<b>SF9FEZ</b> 5-0 x EZ 6-0 x EZ	<b>SF9EZ</b> 5-0 x EZ 6-0 x EZ
<b>TF9FEZ</b> 5-0 x EZ 6-0 x EZ	<b>TF9EZ</b> 6-0 x EZ

20FMB/20MB



Raise & Lower Mini-Blinds

SF  
TF

LITE KIT SIZES (ONLY)
<b>SF20MBEZ</b> 5-0 x EZ 6-0 x EZ
<b>TF20MBEZ</b> 6-0 x EZ

20V



Vented w/Screen  
Lite Kit Available in White Only

SF  
TF

LITE KIT SIZES (ONLY)
<b>SF20VEZ</b> 6-0 x EZ
<b>TF20VEZ</b> 6-0 x EZ

SF Smooth Fiberglass TF Textured Fiberglass

## PATIO HANDING

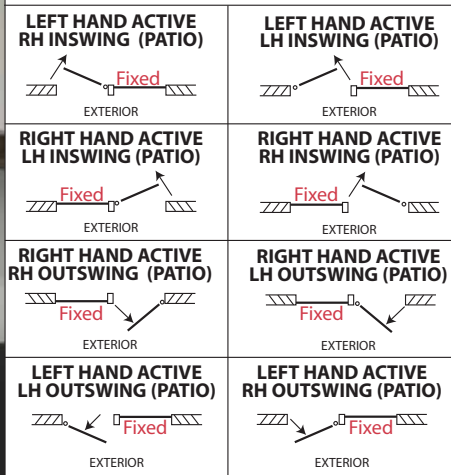

## EZ-Fit (Retro) Net UNIT Sizes

	NET UNIT WIDTH	INSWING ADJ. SILL	OUTSWING BUMPER SILL
5-0 x EZ-FIT	59-3/4"	79-1/2"	78-3/4"
6-0 x EZ-FIT	71-3/4"	79-1/2"	78-3/4"

\*Screen not available on outswings.

## Standard Net UNIT Sizes

	NET UNIT WIDTH	INSWING ADJ. SILL	OUTSWING BUMPER SILL
5-0 x 6-8	62-3/4"	81-3/4"	80-1/2"
5-4 x 6-8	66-3/4"	81-3/4"	80-1/2"
5-8 x 6-8	70-3/4"	81-3/4"	80-1/2"
6-0 x 6-8	74-3/4"	81-3/4"	80-1/2"

\*Screen not available on outswings.

GBG Available w/Grids Between Glass

LE Available w/Low-E Glass

■ Extended Leadtime Required

# Swinging Patio (SP) (only one door opens)

20F/20



Clear/Low-E

10F/10



10 Lite Fixed or GBG

9F/9



9 Lite Marginal, GBG Only

20FMB/20MB



Lite Kit

20V



Vented w/Screen  
Lite Kit Available in White Only

FLUSH-GLAZED SIZES	LITE KIT SIZES
5-0 x 6-8	5-0 x 6-8*
5-4 x 6-8*	5-4 x 6-8*
5-8 x 6-8*	5-8 x 6-8*
6-0 x 6-8	6-0 x 6-8

FLUSH-GLAZED SIZES	LITE KIT SIZES
5-0 x 6-8	5-0 x 6-8*
5-4 x 6-8*	5-4 x 6-8*
5-8 x 6-8*	5-8 x 6-8*
6-0 x 6-8	6-0 x 6-8

FLUSH-GLAZED SIZES	LITE KIT SIZES
5-0 x 6-8	5-0 x 6-8*
5-4 x 6-8*	5-4 x 6-8*
5-8 x 6-8*	5-8 x 6-8*
6-0 x 6-8	6-0 x 6-8

FLUSH-GLAZED SIZES	LITE KIT SIZES
5-0 x 6-8	5-0 x 6-8
5-4 x 6-8*	5-4 x 6-8*
5-8 x 6-8*	5-8 x 6-8*
6-0 x 6-8	6-0 x 6-8

LITE KIT SIZES
5-0 x 6-8
5-4 x 6-8*
5-8 x 6-8*
6-0 x 6-8

SF Smooth Fiberglass TF Textured Fiberglass

\*Not available EZ-Fit (Retro) size.

**NEW**

2022



# 6/8 & 7/0 Eastmont Collection

*Eastmont SFEAS-4401P door with (2) SFEAS-16080 Sidelites with Carbon paint.*



**EAS-230**  
6-8 (26 28 210 30)  
7-0 (28 30) SF Only



**EAS-430**  
6-8 (28 210 30)  
7-0 (28 30) SF Only



**EAS-4301P**  
(28 210 30)



**EAS-4301PC**  
(28 30)



**EAS-4301PSHK**  
(28 210 30)

No matching sidelite available.



**EAS-440**  
(28 30)



**EAS-4401P**  
(30)



**EAS-460**  
6-8 (28 210 30)  
7-0 (28 30) SF Only



**EAS-230**  
6-8 (12" & 14")  
7-0 (14") SF Only



**EAS-240**  
(12" & 14")



**EAS-160**  
6-8 (12" & 14")  
7-0 (14") SF Only

SF Smooth Fiberglass TF Textured Fiberglass FG Fir Grain Textured Fiberglass



# 8/0 Eastmont Collection



EAS-24080  
(SF - 28 30)  
(TF - 30)



EAS-44080  
(SF - 28 30)  
(TF - 30)



EAS-44080P  
(30)



EAS-46080  
(30 36)



EAS-46080P  
(30)



EAS-24080  
(12" & 14")



EAS-16080  
(12" & 14")

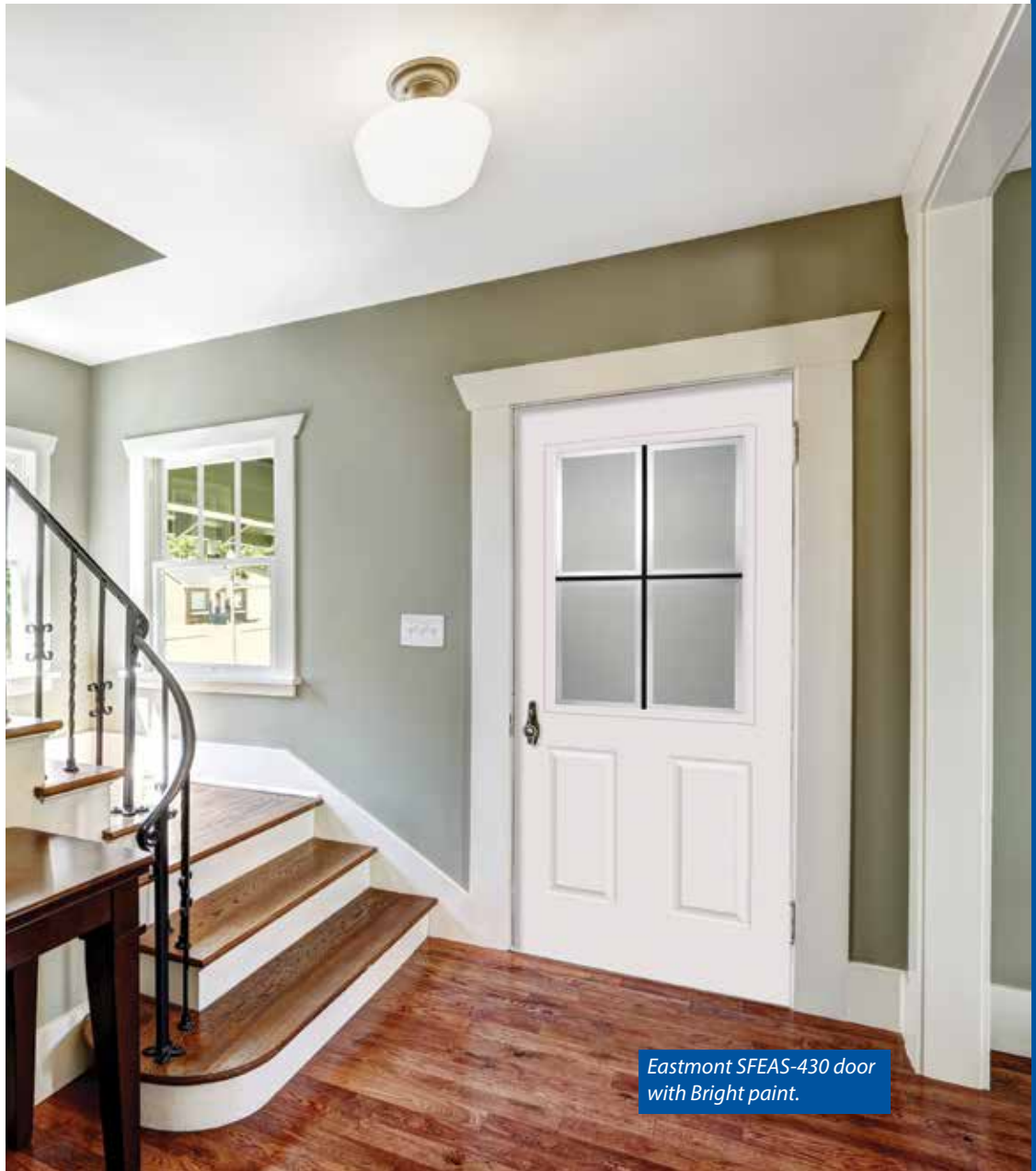

Eastmont SFEAS-430 door  
with Bright paint.

NEW



**Sandblast w/Clear Border**  
Standard Low-E with Argon

# 6/8 & 7/0 Perimeter Collection

*Perimeter SFPER-460 door.  
Paint is not Codel Coatings.*



**PER-230**  
6-8 (26 28 210 30)  
7-0 (28 30) SF Only



**PER-430**  
6-8 (28 210 30)  
7-0 (28 30) SF Only



**PER-4301P**  
(28 210 30)



**PER-4301PC**  
(28 30)



**PER-4301PSHK**  
(28 210 30)

No matching sidelite available.



**PER-440**  
(28 30)



**PER-4401P**  
(30)



**PER-460**  
6-8 (28 210 30)  
7-0 (28 30) SF Only



**PER-230**  
6-8 (12" & 14")  
7-0 (14") SF Only



**PER-240**  
(12" & 14")

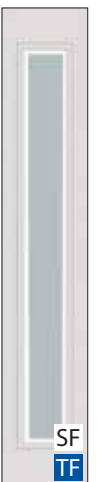

**PER-160**  
6-8 (12" & 14")  
7-0 (14") SF Only

# 8/0 Perimeter Collection



PER-24080  
(SF - 28 30)  
(TF - 30)



PER-44080  
(SF - 28 30)  
(TF - 30)



PER-440801P  
(30)

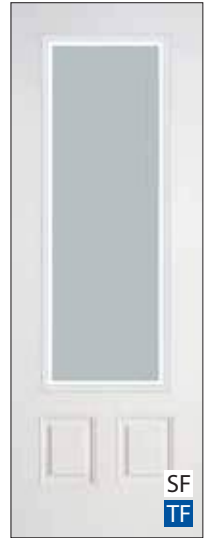

PER-46080  
(30 36)

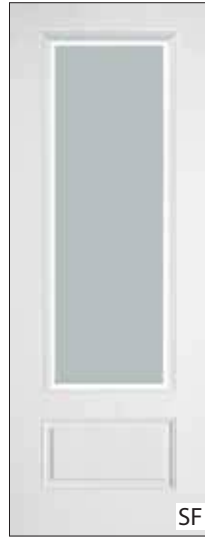

PER-460801P  
(30)

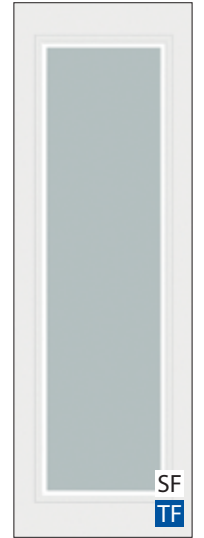

PER-480  
(28 30 36)



PER-24080  
(12" & 14")

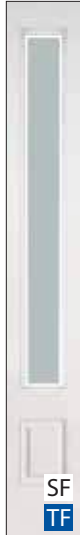

PER-16080  
(12" & 14")

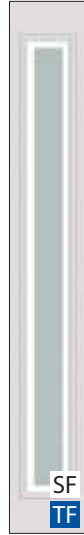

PER-280  
(12" & 14")



Perimeter SFPER-480 doors  
with Bright paint.

**NEW**



**Patina Caming**  
Standard Low-E with Argon

# 6/8 & 7/0 Royston Collection

Royston TFROY-460 door with (2) TFROY-160 sidelites and TFROY-6312 transom. Paint color shown is not Codel Coatings.



ROY-230  
6-8 (26 28 210 30)  
7-0 (28 30) SF Only



ROY-430  
6-8 (28 210 30)  
7-0 (28 30) SF Only



ROY-4301P  
(28 210 30)



ROY-4301PC  
(28 30)



ROY-4301PSHK  
(28 210 30)



ROY-440  
(28 30)

No matching sidelite available.



ROY-4401P  
(30)

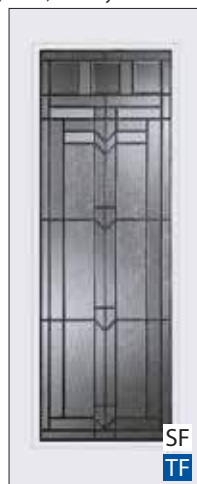

ROY-460  
6-8 (28 210 30)  
7-0 (28 30) SF Only



ROY-200  
(30)

Shown with optional C-21P shelf.



ROY-230  
6-8 (12" & 14")  
7-0 (14") SF Only



ROY-240  
(12" & 14")

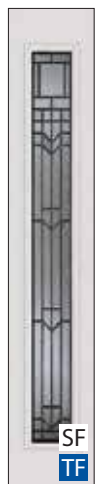

ROY-160  
6-8 (12" & 14")  
7-0 (14") SF Only

# 8/0 Royston Collection



ROY-24080  
(SF - 28' 30"  
TF - 30")



ROY-44080  
(SF - 28' 30"  
TF - 30")



ROY-440801P  
(30")



ROY-46080  
(30' 36")



ROY-460801P  
(30")



ROY-24080  
(12" & 14")

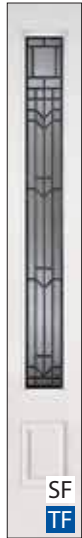

ROY-16080  
(12" & 14")

## Royston Transom

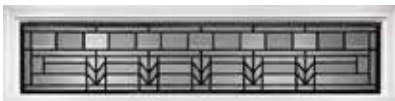

■ ROY-6312 / ROY-6712 / ROY-7212

■ Extended Leadtime Required.  
Refer to Page 114 for Transom Size Information.



Royston TFROY-200 doors and TFROY-6312 transom.  
Stain color shown is not Codel Coatings.

NEW



**Sable**

Standard Low-E with Argon

# 6/8 & 7/0 Sable Collection

Sable TFSAB-460 door and (2) TFSAB-160 sidelites. Stain color is not Codel Coatings.



SAB-230  
6-8 (26 28 210 30)  
7-0 (28 30) SF Only



SAB-430  
6-8 (28 210 30)  
7-0 (28 30) SF Only



SAB-4301P  
(28 210 30)



SAB-4301PC  
(28 30)



SAB-4301PSHK  
(28 210 30)



SAB-440  
(28 30)

No matching sidelite available.



SAB-4401P  
(30)



SAB-460  
6-8 (28 210 30)  
7-0 (28 30) SF Only



SAB-200  
(30)

Shown with optional C-21P shelf.



SAB-230  
6-8 (12" & 14")  
7-0 (14") SF Only



SAB-240  
(12" & 14")



SAB-160  
6-8 (12" & 14")  
7-0 (14") SF Only

# 8/0 Sable Collection

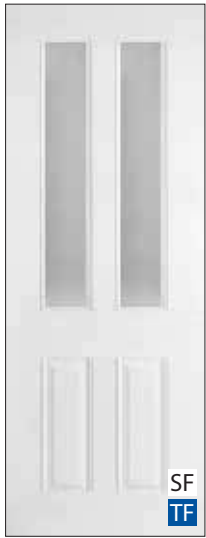

SAB-24080  
(SF - 28 30)  
(TF - 30)



SAB-44080  
(SF - 28 30)  
(TF - 30)



SAB-440801P  
(30)



SAB-46080  
(30 36)



SAB-460801P  
(30)

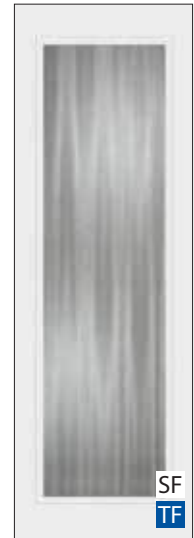

SAB-480  
(28 30 36)



SAB-24080  
(12" & 14")



SAB-16080  
(12" & 14")



SAB-280  
(12" & 14")

## Sable Transom



■ SAB-6312 / SAB-6712 / SAB-7212

■ Extended Leadtime Required.

Refer to Page 114 for Transom Size Information.



Sable SFSAB-460801P door with Bright paint.



**Patina Caming**  
Standard Low-E with Argon

# 6/8 & 7/0 Adelaide Collection

Adelaide SFADE-440 door with (2) SFADE-240 sidelites and SFADE-6312 transom. Paint color shown is not Codel Coatings.



ADE-230  
6-8 (26 28 210 30)  
7-0 (28 30) SF Only



ADE-430  
6-8 (28 210 30)  
7-0 (28 30) SF Only



ADE-4301P  
(28 210 30)



ADE-4301PC  
(28 30)

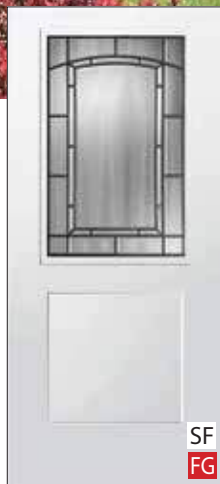

ADE-4301PSHK  
(28 210 30)



ADE-440  
(28 30)

No matching sidelite available.



ADE-4401P  
(30)

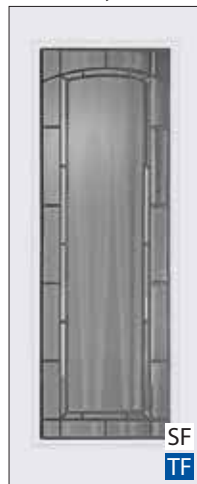

ADE-460  
6-8 (28 210 30)  
7-0 (28 30) SF Only



ADE-200  
(30)

Shown with optional C-21P shelf.



ADE-230  
6-8 (12" & 14")  
7-0 (14") SF Only

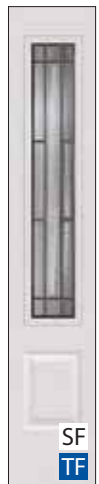

ADE-240  
(12" & 14")

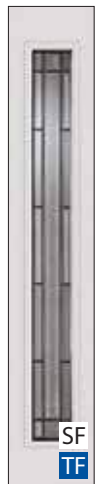

ADE-160  
6-8 (12" & 14")  
7-0 (14") SF Only



# 8/0 Adelaide Collection

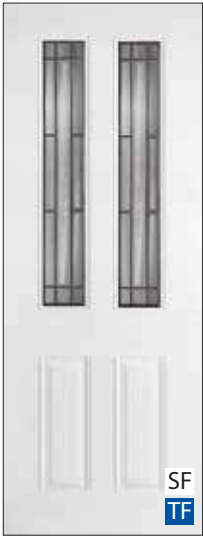

ADE-24080  
(SF - 28 30)  
(TF - 30)



ADE-44080  
(SF - 28 30)  
(TF - 30)



ADE-440801P  
(30)

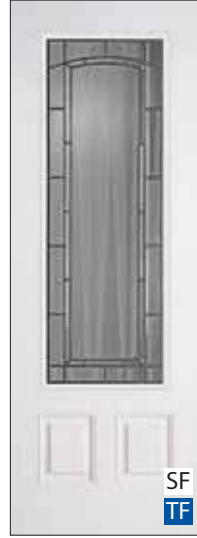

ADE-46080  
(30 36)

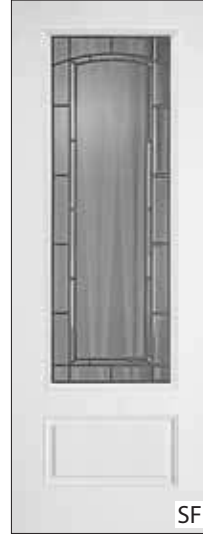

ADE-460801P  
(30)

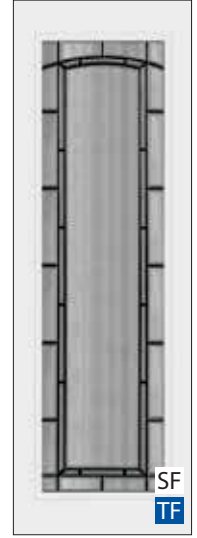

ADE-480  
(28 30 36)



ADE-24080  
(12" & 14")



ADE-16080  
(12" & 14")



ADE-280  
(12" & 14")

## Adelaide Transom



■ ADE-6312 / ADE-6712 / ADE-7212

■ Extended Leadtime Required.  
Refer to Page 114 for Transom Size Information.



Adelaide TFADE-24080 doors. Stain color shown is not Codel Coatings.

Artisan TFART-480 door. Stain color shown is Mahogany.

# 6/8 & 7/0 Artisan Collection



**Patina Caming**  
Standard Low-E with Argon



ART-230  
6-8 (26 28 210 30)  
7-0 (28 30) SF Only



ART-430  
6-8 (28 210 30)  
7-0 (28 30) SF Only



ART-4301P  
(28 210 30)



ART-4301PC  
(28 30)



ART-4301PSHK  
(28 210 30)



ART-440  
(28 30)

No matching sidelite available.



ART-4401P  
(30)



ART-460  
6-8 (28 210 30)  
7-0 (28 30) SF Only



ART-200  
(30)

Shown with optional C-21P shelf.



ART-230  
6-8 (12" & 14")  
7-0 (14") SF Only

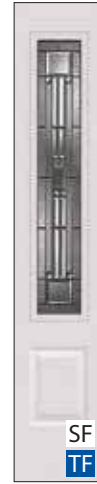

ART-240  
(12" & 14")



ART-160  
6-8 (12" & 14")  
7-0 (14") SF Only

# 8/0 Artisan Collection

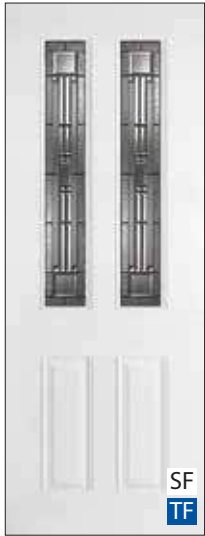

ART-24080  
(SF - 28 30)  
(TF - 30)



ART-44080  
(SF - 28 30)  
(TF - 30)



ART-440801P  
(30)



ART-46080  
(30 36)



ART-460801P  
(30)



ART-480  
(28 30 36)



ART-24080  
(12" & 14")

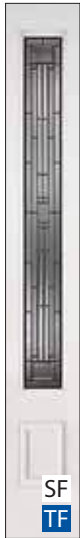

ART-16080  
(12" & 14")



ART-280  
(12" & 14")

## Artisan Transom

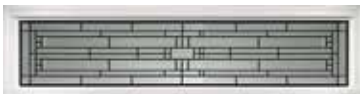

■ ART-6312 / ART-6712 / ART-4212 / ART-7212

■ Extended Leadtime Required.  
Refer to Page 114 for Transom Size Information.



Artisan TFART-46080 doors. Stain color shown is not Codel Coatings.

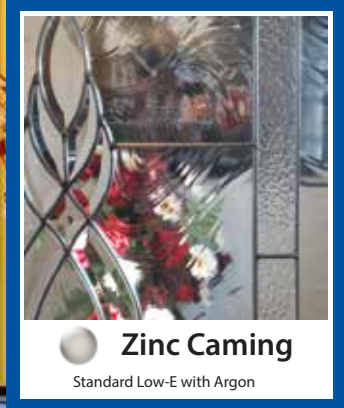

**Zinc Caming**  
Standard Low-E with Argon

# 6/8 & 7/0 Brentwood Collection

*Brentwood SFBRE-460801P door and (2) SFBRE-16080 sidelites with Bright paint.*



**BRE-230**  
6-8 (26 28 210 30)  
7-0 (28 30) SF Only



**BRE-430**  
6-8 (28 210 30)  
7-0 (28 30) SF Only



**BRE-4301P**  
(28 210 30)



**BRE-4301PC**  
(28 30)



**BRE-4301PSHK**  
(28 210 30)



**BRE-440**  
(28 30)

No matching sidelite available.



**BRE-4401P**  
(30)



**BRE-460**  
6-8 (28 210 30)  
7-0 (28 30) SF Only



**BRE-200**  
(30)



**BRE-253**  
(30)

Shown with optional C-21P shelf.



**BRE-230**  
6-8 (12" & 14")  
7-0 (14") SF Only



**BRE-240**  
(12" & 14")



**BRE-160**  
6-8 (12" & 14")  
7-0 (14") SF Only

# 8/0 Brentwood Collection



BRE-24080  
(SF - 28 30)  
(TF - 30)



BRE-44080  
(SF - 28 30)  
(TF - 30)



BRE-440801P  
(30)



BRE-46080  
(30 36)



BRE-460801P  
(30)



BRE-258  
(30)



BRE-25080  
(30 36)



BRE-24080  
(12" & 14")



BRE-16080  
(12" & 14")



*Brentwood TFBRE-44080 door,  
stain is not Codel Coatings.*

Canterbury TFCAN-460 door with (2) TFCAN-160 sidelites & TF CAN-6712 transom. Stain color shown is not Codel Coatings.



**Patina Caming**  
Standard Low-E with Argon

# 6/8 & 7/0 Canterbury Collection



**CAN-230**  
6-8 (26 28 210 30)  
7-0 (28 30) SF Only



**CAN-430**  
6-8 (28 210 30)  
7-0 (28 30) SF Only



**CAN-4301P**  
(28 210 30)



**CAN-4301PC**  
(28 30)



**CAN-4301PSHK**  
(28 210 30)

No matching sidelite available.



**CAN-440**  
(28 30)



**CAN-4401P**  
(30)

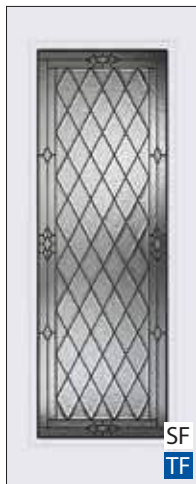

**CAN-460**  
6-8 (28 210 30)  
7-0 (28 30) SF Only

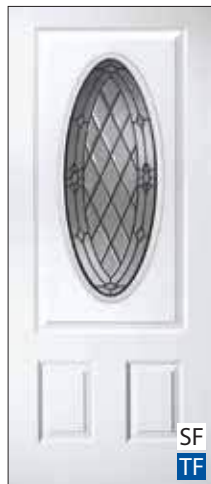

**CAN-949**  
(30)



**CAN-230**  
6-8 (12" & 14")  
7-0 (14") SF Only



**CAN-240**  
(12" & 14")



**CAN-160**  
6-8 (12" & 14")  
7-0 (14") SF Only

# 8/0 Canterbury Collection

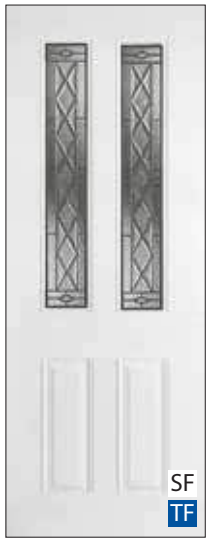

CAN-24080  
(SF - 28 30)  
(TF - 30)



CAN-44080  
(SF - 28 30)  
(TF - 30)



CAN-440801P  
(30)

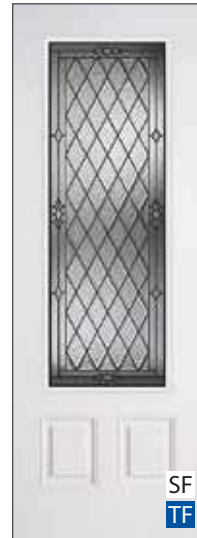

CAN-46080  
(30 36)



CAN-460801P  
(30)



CAN-24080  
(12" & 14")

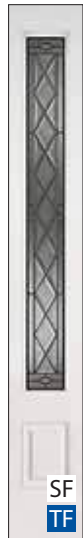

CAN-16080  
(12" & 14")



Canterbury SFCAN-46080 door and SFCAN-16080 sidelite with Burgundy paint.

## Canterbury Transom



■ CAN-6312 / CAN-6712 / CAN-7212

■ Extended Leadtime Required.  
Refer to Page 1014 for Transom Size Information.



**Chord**  
Standard Low-E with Argon

*Chord SFCHO460801P & SFCHO16080 sidelites with Ivory paint.*

# 6/8 & 7/0 Chord Collection



**CHO-230**  
6-8 (26 28 210 30)  
7-0 (28 30) SF Only



**CHO-430**  
6-8 (28 210 30)  
7-0 (28 30) SF Only



**CHO-4301P**  
(28 210 30)



**CHO-4301PC**  
(28 30)



**CHO-4301PSHK**  
(28 210 30)



**CHO-440**  
(28 30)

No matching sidelite available.



**CHO-4401P**  
(30)



**CHO-460**  
6-8 (28 210 30)  
7-0 (28 30) SF Only



**CHO-200**  
(30)

Shown with optional C-2 IP shelf.



**CHO-230**  
6-8 (12" & 14")  
7-0 (14") SF Only



**CHO-240**  
(12" & 14")



**CHO-160**  
6-8 (12" & 14")  
7-0 (14") SF Only



# 8/0 Chord Collection

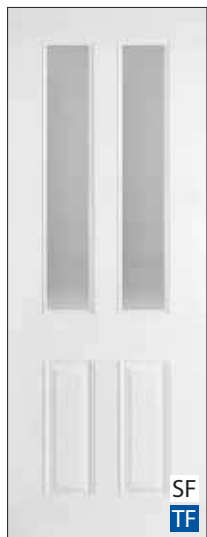

CHO-24080  
(SF - 28 30)  
(TF - 30)



CHO-44080  
(SF - 28 30)  
(TF - 30)



CHO-440801P  
(30)



CHO-46080  
(30 36)



CHO-460801P  
(30)

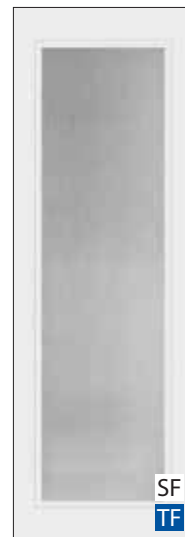

CHO-480  
(28 30 36)



CHO-24080  
(12" & 14")



CHO-16080  
(12" & 14")



CHO-280  
(12" & 14")

## Chord Transom



■ CHO-6312 / CHO-6712 / CHO-7212

■ Extended Leadtime Required.  
Refer to Page 114 for Transom Size Information.



Chord SFCHO-440 door with Bright paint.

Eloquence SFELO-44080 doors with Carbon paint.

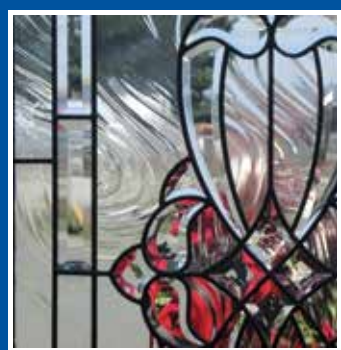

**Patina Caming**  
Standard Low-E with Argon

# 6/8 & 7/0 Eloquence Collection



**ELO-400**  
(SF 28 210 30)  
(TF 26 28 210 30)



**ELO-230**  
6-8 (26 28 210 30)  
7-0 (28 30) SF Only



**ELO-430**  
6-8 (28 210 30)  
7-0 (28 30) SF Only



**ELO-4301P**  
(28 210 30)



**ELO-4301PC**  
(28 30)



**ELO-4301PSHK**  
(28 210 30)



**ELO-440**  
(28 30)



**ELO-4401P**  
(30)

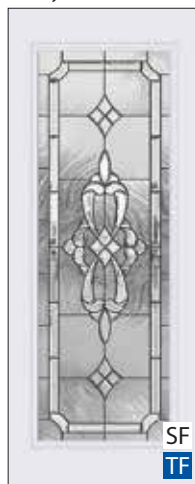

**ELO-460**  
6-8 (28 210 30)  
7-0 (28 30) SF Only



**ELO-230**  
6-8 (12" & 14")  
7-0 (14") SF Only

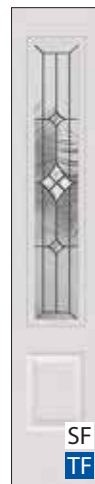

**ELO-240**  
(12" & 14")

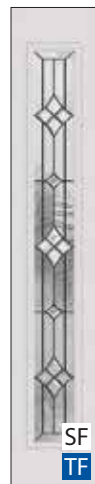

**ELO-160**  
6-8 (12" & 14")  
7-0 (14") SF Only

No matching sidelite available.

SF Smooth Fiberglass TF Textured Fiberglass FG Fir Grain Textured Fiberglass

# 8/0 Eloquence Collection

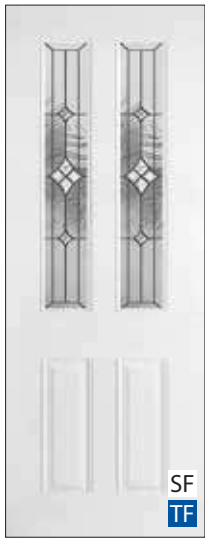

ELO-24080  
(SF - 28' 30"  
(TF - 30)



ELO-44080  
(SF - 28' 30"  
(TF - 30)



ELO-440801P  
(30)

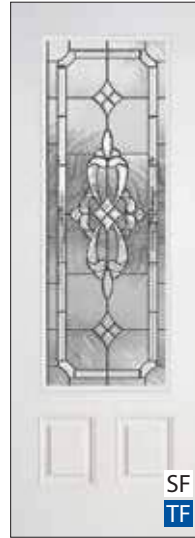

ELO-46080  
(30' 36)



ELO-460801P  
(30)



ELO-24080  
(12" & 14")

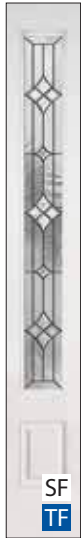

ELO-16080  
(12" & 14")



Eloquence SFELO-46080 door and (2) SFELO-16080 sidelites and Burgundy paint.



Zinc Caming  
 Brass Caming  
 Standard Low-E with Argon

# 6/8 & 7/0 Floret Collection

*Floret TFFLO-24080 door with Medium Oak stain.*



FLO-230  
6-8 (26 28 210 30)  
7-0 (28 30) SF Only



FLO-430  
6-8 (28 210 30)  
7-0 (28 30) SF Only



FLO-4301P  
(28 210 30)



FLO-4301PC  
(28 30)



FLO-4301PSHK  
(28 210 30)

No matching sidelite available.



FLO-440  
(28 30)



FLO-4401P  
(30)

SF Smooth Fiberglass TF Textured Fiberglass FG Fir Grain Textured Fiberglass



FLO-18420V  
(30)



FLO-230  
6-8 (12" & 14"  
7-0 (14") SF Only



FLO-240  
(12" & 14")

## 8/0 Floret Collection



FLO-24080  
(SF - 28 30)  
(TF - 30)



FLO-44080  
(SF - 28 30)  
(TF - 30)



FLO-440801P  
(30)



FLO-24080  
(12" & 14")

## Floret Transom



■ FLO-6312 / FLO-6712 / FLO-7212

■ Extended Leadtime Required.  
Refer to Page 114 for Transom Size Information.

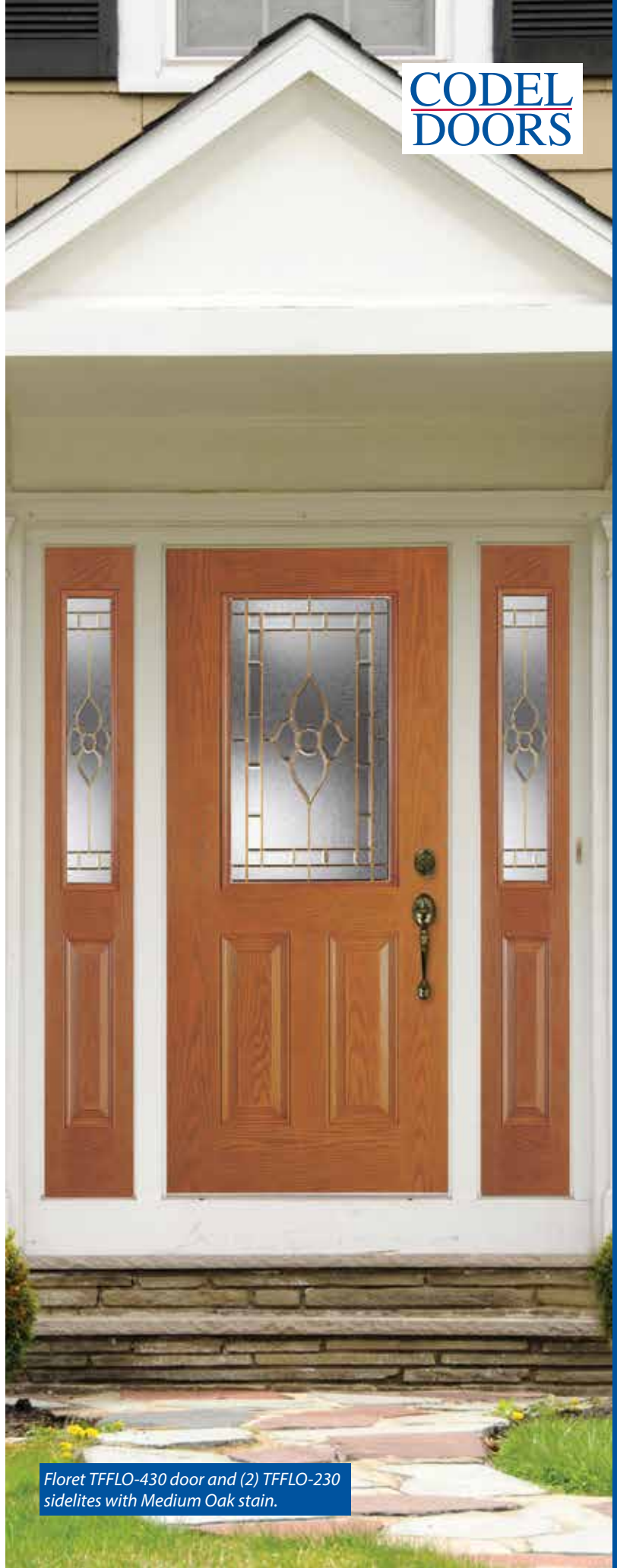

*Floret TFFLO-430 door and (2) TFFLO-230  
sidelites with Medium Oak stain.*



**Patina Caming**  
Standard Low-E with Argon

# 6/8 & 7/0 Harlow Collection

*Harlow SFHAR-440 door with (2) SFHAR-240 sidelites. Stain color shown is not Codel Coatings.*



**HAR-230**  
6-8 (26 28 210 30)  
7-0 (28 30) SF Only



**HAR-430**  
6-8 (28 210 30)  
7-0 (28 30) SF Only



**HAR-4301P**  
(28 210 30)



**HAR-4301PC**  
(28 30)



**HAR-4301PSHK**  
(28 210 30)



**HAR-440**  
(28 30)

No matching sidelite available.



**HAR-4401P**  
(30)



**HAR-460**  
6-8 (28 210 30)  
7-0 (28 30) SF Only



**HAR-200**  
(30)

Shown with optional C-21P shelf.



**HAR-230**  
6-8 (12" & 14")  
7-0 (14") SF Only

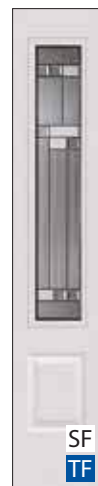

**HAR-240**  
(12" & 14")

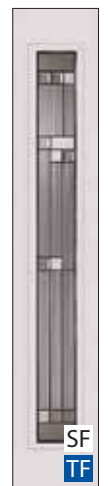

**HAR-160**  
6-8 (12" & 14")  
7-0 (14") SF Only

# 8/0 Harlow Collection

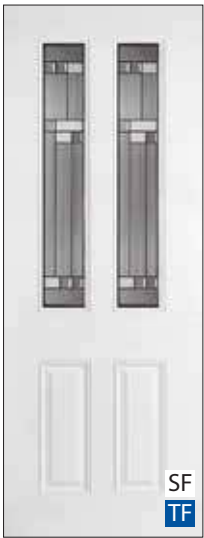

HAR-24080  
(SF - 28 30)  
(TF - 30)



HAR-44080  
(SF - 28 30)  
(TF - 30)



HAR-440801P  
(30)



HAR-46080  
(30 36)



HAR-460801P  
(30)

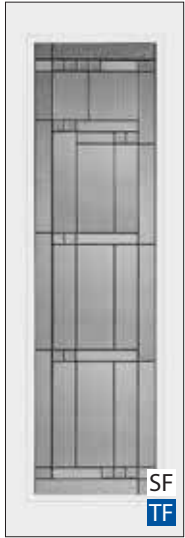

HAR-480  
(28 30 36)



HAR-24080  
(12" & 14")

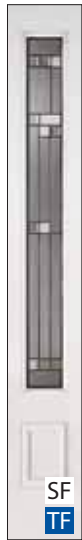

HAR-16080  
(12" & 14")



HAR-280  
(12" & 14")

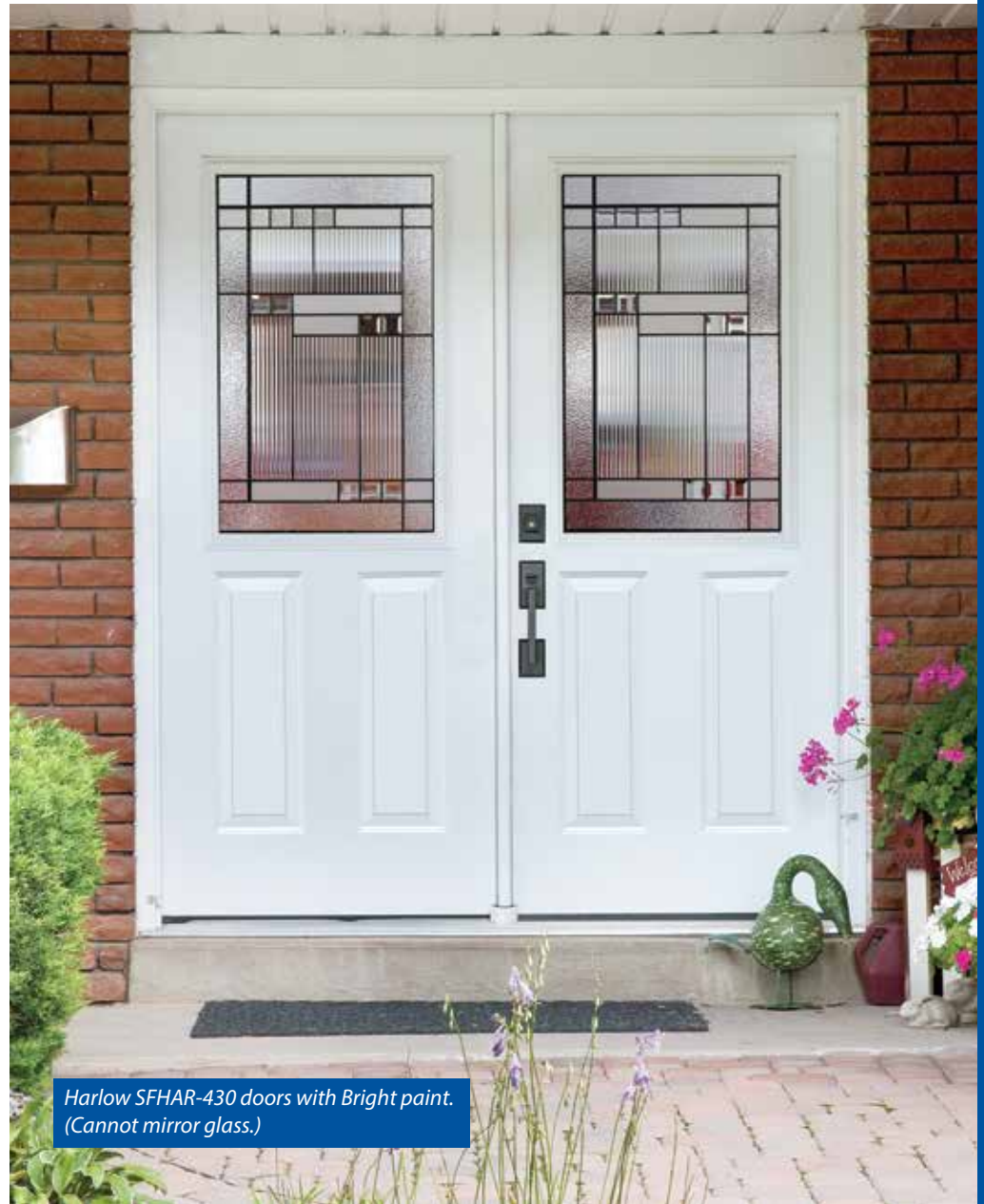

## Harlow Transom



■ HAR-6312 / HAR-6712 / HAR-7212

■ Extended Leadtime Required.  
Refer to Page 114 for Transom Size Information.



# 6/8 & 7/0 Maren Collection

Maren SFMAR-460 door with Carbon paint.

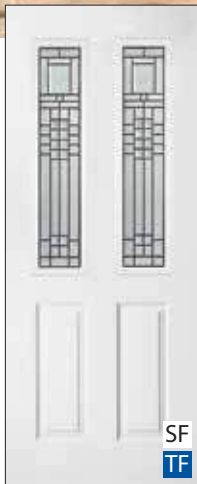

MAR-230  
6-8 (26 28 210 30)  
7-0 (28 30) SF Only

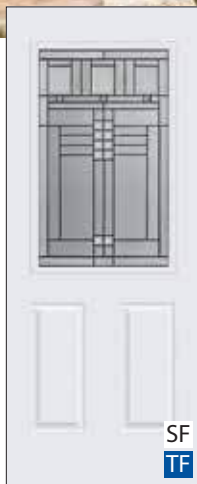

MAR-430  
6-8 (28 210 30)  
7-0 (28 30) SF Only



MAR-4301P  
(28 210 30)



MAR-4301PC  
(28 30)



MAR-4301PSHK  
(28 210 30)



MAR-440  
(28 30)

No matching sidelite available.



MAR-4401P  
(30)

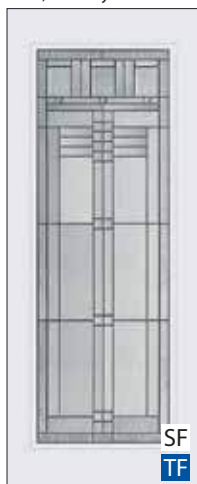

MAR-460  
6-8 (28 210 30)  
7-0 (28 30) SF Only



MAR-200  
(30)

Shown with optional C-2 IP shelf.



MAR-230  
6-8 (12" & 14")  
7-0 (14") SF Only

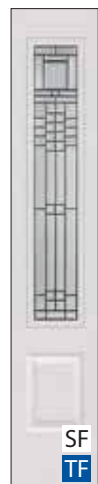

MAR-240  
(12" & 14")

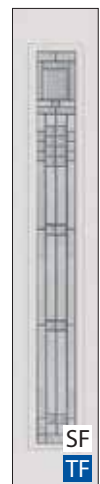

MAR-160  
6-8 (12" & 14")  
7-0 (14") SF Only



# 8/0 Maren Collection

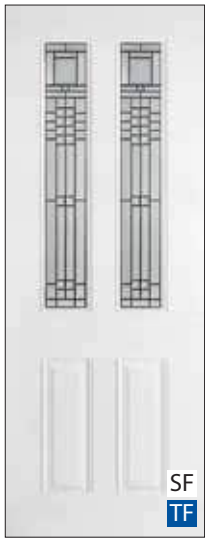

MAR-24080  
(SF - 28 30)  
(TF - 30)

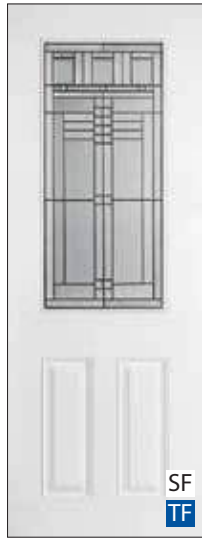

MAR-44080  
(SF - 28 30)  
(TF - 30)



MAR-440801P  
(30)



MAR-46080  
(30 36)



MAR-460801P  
(30)



MAR-24080  
(12" & 14")

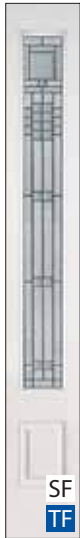

MAR-16080  
(12" & 14")

## Maren Transom



■ MAR-6312 / MAR-6712 / MAR-7212

■ Extended Leadtime Required.  
Refer to Page 114 for Transom Size Information.



Maren SFMAR-200 door with Bright paint.

Modena SFMOD-4401P80 door. Paint color shown is not Codel Coatings.

Patina Caming  
 Zinc Caming  
 Standard Low-E with Argon

# 6/8 & 7/0 Modena Collection

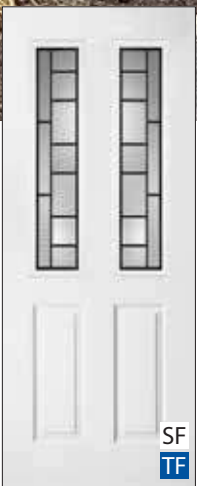

MOD-230  
6-8 (26 28 210 30)  
7-0 (28 30) SF Only



MOD-430  
6-8 (28 28 210 30)  
7-0 (28 30) SF Only



MOD-4301P  
(28 210 30)



MOD-4301PC  
(28 30)

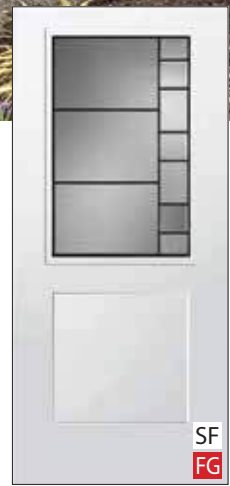

MOD-4301PSHK  
(28 210 30)



MOD-440  
(28 30)

No matching sidelite available.

SF Smooth Fiberglass TF Textured Fiberglass FG Fir Grain Textured Fiberglass (Zinc Caming Available Upon Request)



MOD-4401P  
(30)



MOD-460  
6-8 (28 210 30)  
7-0 (28 30) SF Only



MOD-200  
(30)

Shown with optional C-2 IP shelf.



MOD-230  
6-8 (12" & 14")  
7-0 (14") SF Only



MOD-240  
(12" & 14")



MOD-160  
6-8 (12" & 14")  
7-0 (14") SF Only

## 8/0 Modena Collection

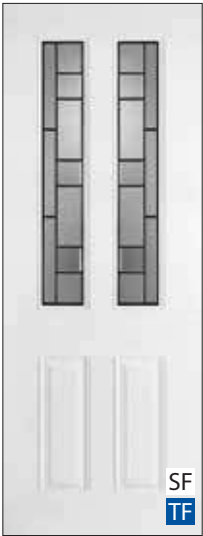

MOD-24080  
(SF - 28 30)  
(TF - 30)



MOD-44080  
(SF - 28 30)  
(TF - 30)



MOD-440801P  
(30)

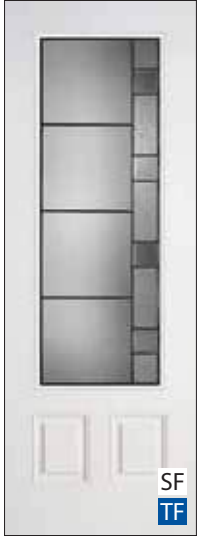

MOD-46080  
(30 36)

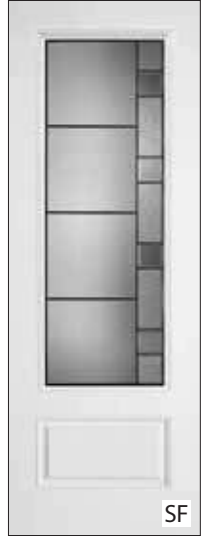

MOD-460801P  
(30)



MOD-480  
(28 30 36)



MOD-24080  
(12" & 14")



MOD-16080  
(12" & 14")



MOD-280  
(12" & 14")

### Modena Transom



■ MOD-6312 / MOD-6712 / MOD-7212

■ Extended Leadtime Required.  
Refer to Page 114 for Transom Size Information.



# 6/8 & 7/0 Narrows Collection

*Narrows SFNAR-440 doors with Bright paint.*

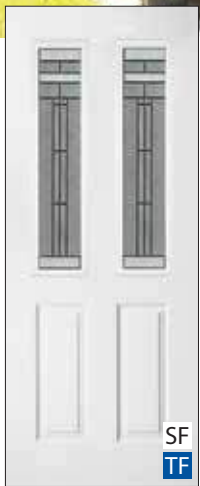

**NAR-230**  
6-8 (26 28 210 30)  
7-0 (28 30) SF Only



**NAR-430**  
6-8 (28 210 30)  
7-0 (28 30) SF Only



**NAR-4301P**  
(28 210 30)



**NAR-4301PC**  
(28 30)



**NAR-4301PSHK**  
(28 210 30)

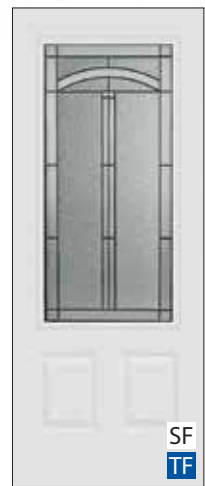

**NAR-440**  
(28 30)

No matching sidelite available.



**NAR-4401P**  
(30)



**NAR-460**  
6-8 (28 210 30)  
7-0 (28 30) SF Only



**NAR-200**  
(30)

Shown with optional C-21P shelf.



**NAR-230**  
6-8 (12" & 14")  
7-0 (14") SF Only



**NAR-240**  
(12" & 14")

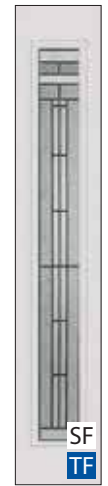

**NAR-160**  
6-8 (12" & 14")  
7-0 (14") SF Only

# 8/0 Narrows Collection



NAR-24080  
(SF - 28 30)  
(TF - 30)



NAR-44080  
(SF - 28 30)  
(TF - 30)



NAR-440801P  
(30)

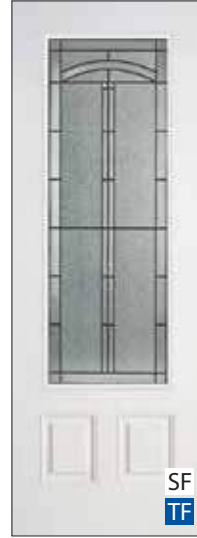

NAR-46080  
(30 36)



NAR-460801P  
(30)



NAR-24080  
(12" & 14")

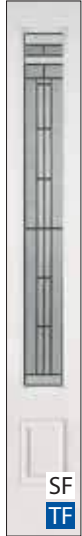

NAR-16080  
(12" & 14")



Narrows SFNAR-430 door and (2) SFNAR-230  
sidelites with Hunter paint.



# 6/8 & 7/0 Niagara Collection

*Niagara SFNIA-440 door and (2) SFNIA-240 sidelites with Tomato paint.*



**NIA-400**  
(SF 28 210 30)  
(TF 26 28 210 30)



**NIA-230**  
6-8 (26 28 210 30)  
7-0 (28 30) SF Only



**NIA-430**  
6-8 (28 210 30)  
7-0 (28 30) SF Only



**NIA-4301P**  
(28 210 30)



**NIA-4301PC**  
(28 30)



**NIA-4301PSHK**  
(28 210 30)

No matching sidelite available.



**NIA-440**  
(28 30)



**NIA-4401P**  
(30)



**NIA-230**  
6-8 (12" & 14")  
7-0 (14") SF Only



**NIA-240**  
(12" & 14")



# 8/0 Niagara Collection



NIA-24080  
(SF - 28" 30")  
(TF - 30")



NIA-44080  
(SF - 28" 30")  
(TF - 30")



NIA-440801P  
(30")



NIA-24080  
(12" & 14")



Niagara SFNIA-230 doors with Bright paint.





**Satin Etch**  
Standard Low-E with Argon

# 6/8 & 7/0 Satin Etch Collection

*Satin Etch TFSAT-460 door. Stain color shown is not Codel Coatings.*



**SAT-230**  
6-8 (26 28 210 30)  
7-0 (28 30) SF Only

SF  
TF



**SAT-430**  
6-8 (28 210 30)  
7-0 (28 30) SF Only

SF  
TF



**SAT-4301P**  
(28 210 30)

SF



**SAT-4301PC**  
(28 30)

SF



**SAT-4301PSHK**  
(28 210 30)

SF  
FG



**SAT-440**  
(28 30)

SF  
TF

No matching sidelite available.





SAT-4401P  
(30)



SAT-460  
6-8 (28 210 30)  
7-0 (28 30) SF Only



SAT-200  
(30)

Shown with optional C-21P shelf.



SAT-230  
6-8 (12" & 14")  
7-0 (14") SF Only



SAT-240  
(12" & 14")



SAT-160  
6-8 (12" & 14")  
7-0 (14") SF Only

## 8/0 Satin Etch Collection



SAT-24080  
(SF - 28 30)  
(TF - 30)



SAT-44080  
(SF - 28 30)  
(TF - 30)



SAT-440801P  
(30)



SAT-46080  
(30 36)



SAT-460801P  
(30)

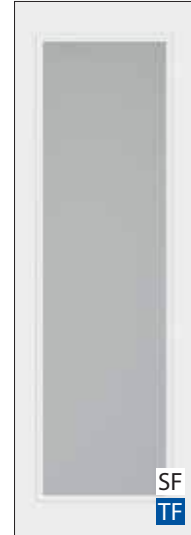

SAT-480  
(28 30 36)



SAT-24080  
(12" & 14")

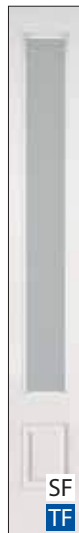

SAT-16080  
(12" & 14")

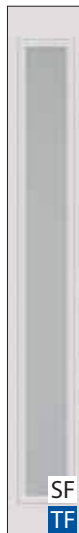

SAT-280  
(12" & 14")

### Satin Etch Transom



■ SAT-6312 / SAT-6712 / SAT-7212

■ Extended Leadtime Required.  
Refer to Page 114 for Transom Size Information.

Waterton SFWAT-46080 door with SFWAT-16080 sidelite. Paint color shown is not Codel Coatings.



# 6/8 & 7/0 Waterton Collection



WAT-230  
6-8 (26 28 210 30)  
7-0 (28 30) SF Only



WAT-430  
6-8 (28 210 30)  
7-0 (28 30) SF Only



WAT-4301P  
(28 210 30)



WAT-4301PC  
(28 30)



WAT-4301PSHK  
(28 210 30)



WAT-440  
(28 30)

No matching sidelite available.



WAT-4401P  
(30)



WAT-460  
6-8 (28 210 30)  
7-0 (28 30) SF Only



WAT-64  
(30)



WAT-200  
(30)

Shown with optional C-21P shelf.



WAT-230  
6-8 (12" & 14")  
7-0 (14") SF Only



WAT-240  
(12" & 14")

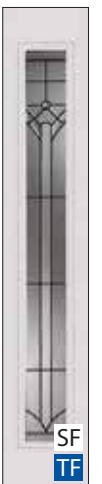

WAT-160  
6-8 (12" & 14")  
7-0 (14") SF Only

# 8/0 Waterton Collection

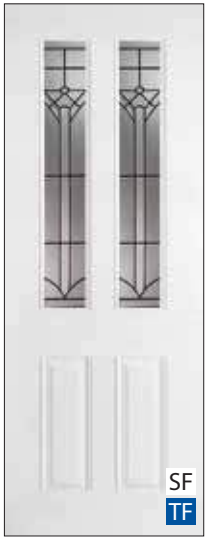

WAT-24080  
(SF - 28 30)  
(TF - 30)



WAT-44080  
(SF - 28 30)  
(TF - 30)



WAT-440801P  
(30)



WAT-46080  
(SF 36)  
(30 36)



WAT-460801P  
(30)



WAT-480  
(28 30 36)

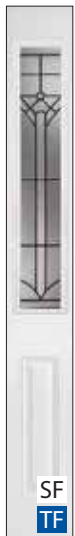

WAT-24080  
(12" & 14")

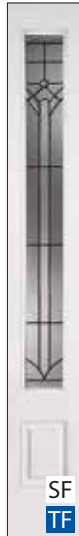

WAT-16080  
(12" & 14")



WAT-280  
(12" & 14")

## Waterton Transom



■ WAT-6312 / WAT-6712 / WAT-7212

■ Extended Leadtime Required.  
Refer to Page 114 for Transom Size Information.



Waterton SFWAT-460 door. Paint color shown is not Codel Coatings.

# Obscure Glass Options

Codel offers a variety of obscure glass options. Obscurity levels range from glass that lets in plenty of light and definable detail, to obscurity options offering various degrees of privacy.



**Chord**



**Monumental**



**Narrow Reed**



**Pinhead**



**Rain**



**Sable**



**Satin Etch**



**Screen Dot**



**Travertine**



**White Laminate**

Most Obscure Glass Options are not available in stock and require longer extended leadtimes. Please check with Codel Representative for availability.

# Specialty Glass Options

Codel offers additional Specialty glass options. These include sound-proofing glass for noise reduction, thicker glass for added strength, reduction in solar heat gain, and more Low-E options. Contact Codel for more information.



SF20 door glass.

**SF64/TF64**



**SF648**



**SF3P**



**SF61**



**SF81**



**SF20**



**SFSL1**



**SFSL8**



**SFSL20**



**Direct Set**



## More Choices in Specialty Glass

- Reduce noise with sound-proofing glass
- Thicker glass options for added strength and higher solar heat gain coefficient
- Additional Low-E glass options to meet higher U-Values
- GBG with color
- Custom Textures & Custom Decorative Glass
- Extended Leadtimes

# Inswing Split Finish (Optional)

Want one color on the outside of your door to complement your home's exterior and a different color on the inside to match your interior? Codel Doors offers 21 paint and 7 stain colors (see back cover) to customize your door for just the right look. Ask your Codel rep. for information.

## Inswing (Exterior View)



## Inswing Unit - Split Finish

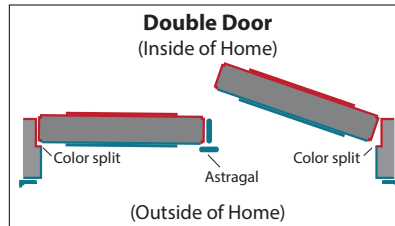
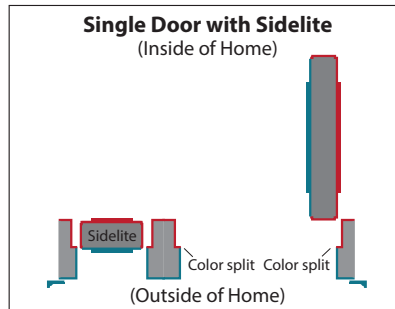
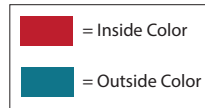

Color is split at center groove of the proud edge.

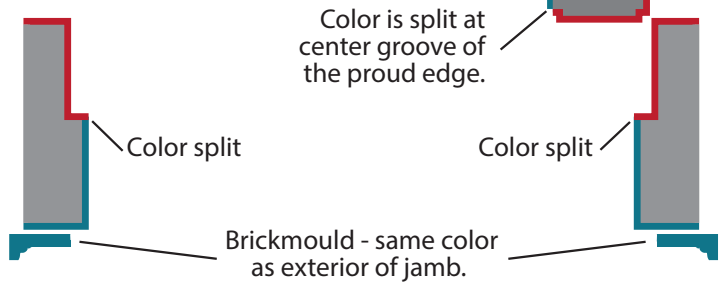

Color samples are reproduced as close as possible, actual color may vary.

# Outswing Split Finish (Optional)

Want one color on the outside of your door to complement your home's exterior and a different color on the inside to match your interior? Codel Doors offers 21 paint and 7 stain colors (see back cover) to customize your door for just the right look. Ask your Codel rep. for information.

## Outswing (Exterior View)



### Outswing Unit - Split Finish

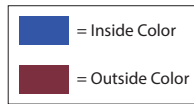

(Inside of Home)

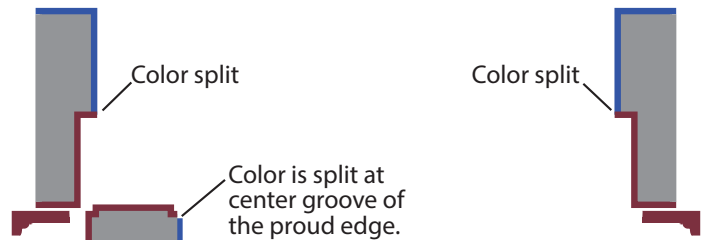

(Outside of Home)

Color is split at center groove of the proud edge.

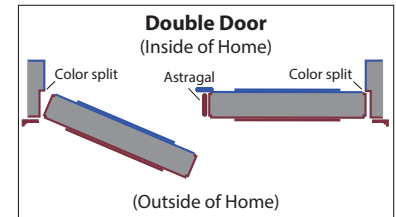
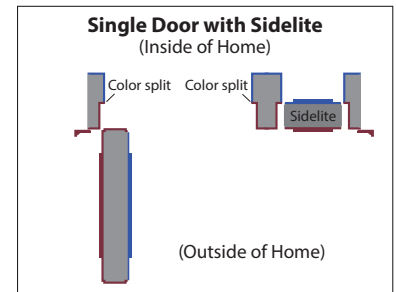

Color samples are reproduced as close as possible, actual color may vary.

# WeatherGuard

COMPOSITE FRAME

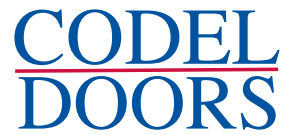

SF20F door with Bright paint.







Codel's WeatherGuard Composite Frame System is an innovative alternative to traditional wood jambs. This poly-fiber doorframe system combines all the strength and convenience of wood with enhanced properties that make it moisture, rot and insect resistant. This unique formulation guarantees that the WeatherGuard frame will not absorb or wick moisture and resists warping, splintering and rotting.

The WeatherGuard product line is available in two varieties. White Cap is a smooth, semi-gloss white that can be painted or left unfinished to compliment the Codel Smooth Fiberglass door. Textured has an embossed grain that can be painted or stained to compliment the Codel Textured Fiberglass door. The advanced WeatherGuard system can be installed the same way as traditional wood jambs.

Exclusive to WeatherGuard is our patented "Seams-Rite" spline that enables the brickmould to be applied to the jamb without using nails. Besides eliminating nail holes, "Seams-Rite" ensures a continuous water barrier.



(Vinyl nailing flange is optional.)

White Cap	<b>Jamb</b>		<b>Jamb</b>	
	<b>2" Brickmould</b>		<b>2" Brickmould</b>	
	<b>Mullpost</b>		<b>Mullpost</b>	
	Textured Embossed			

## Features & Benefits

- Poly-fiber composite jamb system is an attractive, affordable, and low maintenance option to traditional wood
- Closed cellular structure is a unique formulation that ensures product will not warp, split or absorb moisture
- Greater screw holding power than wood
- Installs the same as traditional wood jambs
- Available in smooth semi-gloss white cap and stainable textured embossed
- Matching mullposts offering sidelite and transom capabilities
- Installation and finishing recommendation label applied to every frame
- Limited lifetime warranty



# Adjustable Sill Pan

The Adjustable Sill Pan is a durable, PVC plastic unit that helps you protect your sill and entry door from water damage.



- Sloped weep areas located beneath the jamb-to-sill joint that direct moisture away from areas that could be damaged
- Durable weather-resistant material impervious to rust, corrosion, galvanic corrosion, electrolysis and corrosive coastal areas
- Depths to accommodate most door applications in either 2 x 4 or 2 x 6 construction
- Easy installation with the multiple piece design

**Available in  
4-9/16" & 6-9/16"**

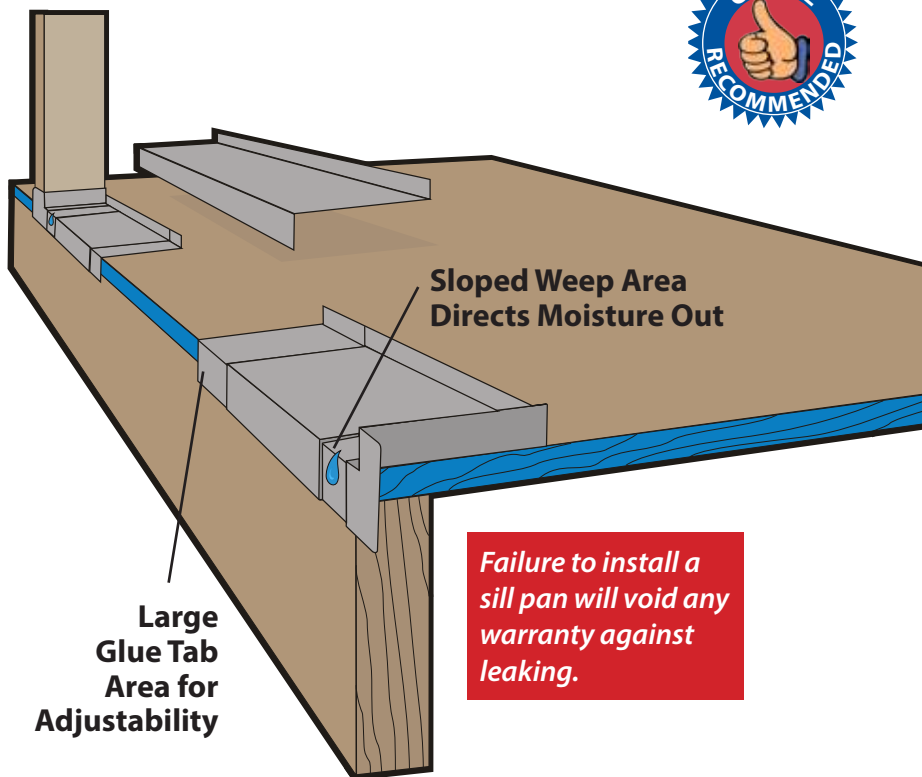

# Jamb Options

Available sizes: 4-9/16", 5-1/4", 6-9/16", and 7-1/4".



**White Cap Composite Jamb**



**Textured Tan Composite Jamb**

## Primed Finger Solid Wood Joint

Our domestic Ponderosa pine door frames are treated with blue acrylic end sealer to prevent wicking. Sealer is applied to bottom of jamb.

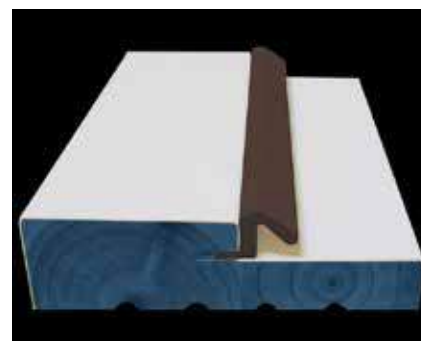

## Weatherstrip Options

Brown weatherstrip is the CODEL standard, white is available upon request.

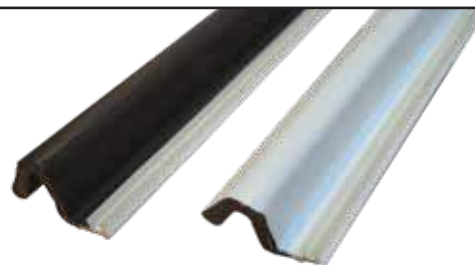

## Inswing Water-Shed Sill

- Built-in weep system
- All composite for durability
- Special bumper sweep compensates for gaps; no adjustment needed
- Water-tight butyl end seal gasket



## Inswing Adjustable Sill

- High performance Imperial seal technology
- All composite for durability
- Adjustable rail ensuring a tight fit
- Water-tight butyl end seal gasket



## Inswing Fixed Sill

- Thermal efficient composite cap
- Durable economic design
- Water-tight butyl end seal gasket



## Outswing Bumper Sill

- All-aluminum durability
- High performance outswing design
- Water-tight butyl end seal gasket



## Outswing Oak Bumper Sill

- Stain grade hardwood interior
- High performance outswing design
- Water-tight butyl end seal gasket



## LowPro Sill (Inswing or Outswing)

- ADA compliant
- Durable all-aluminum design
- Not recommended for high weather exposure



**All Sills Available in:**



Mill Finish

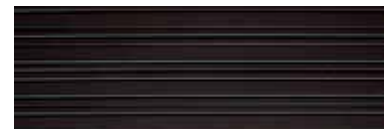

Bronze Finish

# High Performance Commercial Grade Ball Bearing Hinges are **Standard** on Codel Fiberglass Doors

## Strength and Durability:

Heavy-duty commercial strength hinge, that is much thicker than the standard residential hinge found on most residential fiberglass doors in the industry. This stronger hinge keeps your door true and fit in the opening, and reduces the risk of sagging.

## Smooth Operation:

Our heavy-duty hinges come standard with ball bearings, giving your entry door ease of opening and years of quiet operation.

## Appearance and Security:

With a thickness of 3.3mm, and ¼ radius, these hinges are not only aesthetically pleasing, but are more secure than the traditional residential hinge. These hinges are sealed on the top and bottom, so pin is not removable.



**US15 Satin Nickel**  
(Non-Ferrous or \*Self-Closing  
Options Also Available)



**US26 Bright Chrome**  
(Non-Ferrous or \*Self-Closing  
Options Also Available)



**US26D Brushed Chrome**  
(Non-Ferrous or \*Self-Closing  
Options Also Available)



**US1D Black**  
(Non-Ferrous or \*Self-Closing  
Options Also Available)



**US10B Bronze**  
(Non-Ferrous or \*Self-Closing  
Options Also Available)



**US3 Brass**  
(Non-Ferrous or \*Self-Closing  
Options Also Available)



**US4 Satin Brass**  
(Non-Ferrous or \*Self-Closing  
Options Also Available)



**US5 Antique Brass**  
(Non-Ferrous or \*Self-Closing  
Options Also Available)



**US32D Stainless Steel**  
(Non-Ferrous)

\*Self-Closing Hinges **ARE NOT** Ball Bearing.

***Non-Ferrous hinges help prevent rust and corrosion and are standard on all outswing fiberglass doors.***

## Steel Door Standard Hinge



Our steel doors come with a standard weight hinge, available in the same color choice options noted above.



# MultiPoint Locking Systems

Codel Doors offers MultiPoint Locking Systems of the finest design, most precise machining and highest quality materials, providing homeowners with a secure locking system stronger than traditional deadbolt locks.



### Screw Support

Prevents flexing or bending of the gear for life-time performance and smoother operation.



### Mishandling Device

Prevents multiple locking points from accidentally firing and potentially damaging door trim. Fully field reversible.



### Solid Stainless Steel Deadbolt

Highly corrosion resistant and stronger than traditional deadbolts.



### Manual Tongue (Top & Bottom)

While offering security in the locked position, the manual tongue engages into the jamb or mull post and retracts when opened, giving a smooth, clean appearance.



### Flush Bolts (Top & Bottom)

*(Optional) MultiPoint is available for the inactive door.* The flush-bolts operate by the handle on the inactive panel, sending the flush bolts simultaneously into the head and sill, offering smooth and easy operation and securing your entry door.



Traditional

Contemporary



Bronze



Brushed Chrome



Euro



Satin Nickel



Bronze

(Deadbolt not shown.)

## MultiPoint Hardware Options & Finishes

### Features and Benefits

- 300 Series Stainless Steel-Highly corrosion resistant
- Self Lubricating Parts - Last longer by eliminating the need to lubricate locks
- Helps prevent doors from bowing and adds extra security at the same time
- Schlage Keyway

- Only available on Fiberglass door units.  
- Not available on cut-down units.



# MultiPoint - Grip Series

TONGUE LATCH SYSTEM



## Finishes



Satin Nickel

Bronze

Multiple locking points maintain door panel integrity, prevent door warpage, improve weather resistance and increase security.



Consumer friendly with 1/4 turn deadbolt lock indicator.

## Savoy



Available in Satin Nickel & Oil Rubbed Bronze finishes.

## Windsor



Available in Satin Nickel & Oil Rubbed Bronze finishes.

## Lumina



Available in Satin Nickel & Oil Rubbed Bronze finishes.

## Grip & Lever Series Features

- Available for 6/8, 7/0 and 8/0 Doors
- Available in Satin Nickel and Oil Rubbed Bronze
- Conventional Deadbolt and Lever Handle Spacing at 5-1/2"
- Adjustable Strike Plates
- Dummy Sets Available for Double Door Units
- Deadbolts & Levers Meet ANSI Grade 2 Standards
- Schlage Keyway

Only Available on Fiberglass Door Units.

# CODEL DOORS



# MultiPoint - Lever Series

TRIPLE LATCH SYSTEM



3 latches automatically engage when door closes to prevent door warpage and increase security.

Consumer friendly with 1/4 turn deadbolt lock indicator.



Adjustable strikes for optimum operation.

Extended strike for outswing units.



## Finishes



Satin Nickel      Bronze



Bright Chrome

(Available on Times Verona ONLY)

Only Available on Fiberglass Door Units.

## Classique



Available in Satin Nickel & Oil Rubbed Bronze finishes.

## Classique Monaco



Available in Satin Nickel & Oil Rubbed Bronze finishes.

## Classique Verona



Available in Satin Nickel & Oil Rubbed Bronze finishes.

## Times



Available in Satin Nickel & Oil Rubbed Bronze finishes.

## Times Verona



Available in Satin Nickel, Oil Rubbed Bronze & Bright Chrome finishes.

## Dahli



Available in Satin Nickel & Oil Rubbed Bronze finishes.

## Dahli Verona



Available in Satin Nickel & Oil Rubbed Bronze finishes.

## Grip & Lever Series Features

- Available for 6/8, 7/0 and 8/0 Doors
- Conventional Deadbolt and Lever Handle Spacing at 5-1/2"
- Adjustable Strike Plates
- Dummy Sets Available for Double Door Units
- Deadbolts & Levers Meet ANSI Grade 2 Standards
- Schlage Keyway

# Contemporary Door Pulls



## Roller Catch

Two heavy-duty roller catches located near the top and bottom of the door ensure a secure closure. Available in Satin Nickel and Oil Rubbed Bronze.



Only Available on Fiberglass Door Units.



**24"  
Round  
Door  
Pull**

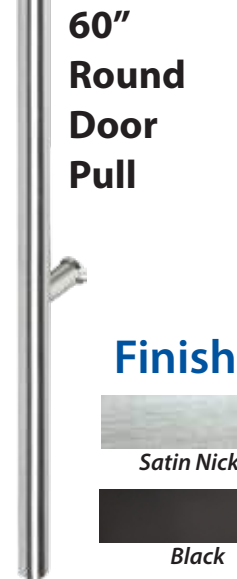

**60"  
Round  
Door  
Pull**

## Finishes



*Satin Nickel*



*Black*

*60" Round Door Pull only available in 3-0 lip lite configuration.*

**CODEL  
DOORS**

# Door Configurations



Single Prehung



Single Prehung with Sidelite on the Strike Side  
*(This is Codel's STANDARD)*

Also available with Sidelite on hinge side.



\*Single Prehung with "Direct-Set" Style Sidelite on the Strike Side  
*(Available with Smooth or Oak Grain Textured Fiberglass Panel ONLY)*

Also available with Sidelite on hinge side.



Single Prehung with Two Sidelites

Also available with Direct Sidelite option.



Double Prehung



\*\*Double Prehung with Two Sidelites

Also available with Direct Sidelite option.



\*\*\*Patio Unit (Hinged off the Mull Post)  
R-H Active / L-H Swing



\*\*\*Patio Unit (Hinged off the Mull Post)  
L-H Active / R-H Swing

\*Single Prehung with "Direct-Set" Style Sidelite: Available 6/8 and 7/0 Only. 8/0 Direct sidelite available on hinge side.

\*\* Double Prehung Unit: (aka "Pair of Doors" and "French Doors") Both Doors Open - One active door and one inactive (passive) door. The inactive door has an astragal with flush bolts attached to it to keep it stationary when not in use.

\*\*\* Patio Unit: (aka "Atrium Unit") Only ONE door opens - One operable door and one fixed door - The fixed door will never open.





Single Prehung with Transom Above



Single Prehung with Sidelite on the Strike Side and Transom Above

Also available with Direct Sidelite option.



Single Prehung with Sidelite on the Hinge Side and Transom Above

Also available with Direct Sidelite option.



Single Prehung with Two Sidelites and Transom Above

Also available with Direct Sidelite option.



\*\*Double Prehung with Transom Above



\*\*Double Prehung with Two Sidelites and Transom Above

Also available with Direct Sidelite option.



\*\*\*Patio Unit (Hinged off the Jamb) R-H Active / R-H Swing



\*\*\*Patio Unit (Hinged off the Jamb) L-H Active / L-H Swing

# Decorative Transom Sizes & Door Handing

## DECORATIVE TRANSOM SIZES

SERIES	FOR USE OVER	ACTUAL GLASS SIZE	*NET UNIT SIZE
6312	Use Over 3-0 Door w/2 Ea. 12" Sidelites	62-3/4" x 12"	64-3/8" x 95-3/8"
6712	Use Over 3-0 Door w/2 Ea. 14" Sidelites	66-3/4" x 12"	68-3/8" x 95-3/8"
7212	Use Over 6-0 DBL. Door (NO Sidelites)	72-1/4" x 12"	73-7/8" x 95-3/8"

*\*Net Unit Height includes a 6-8 INSWING prehung with standard fixed or adjustable sill - For OUTSWING Unit, deduct 1-1/4" from Net Unit Height.*

*For 7-0 prehung, add 4" to Net Unit Height.*

*For 8-0 prehung, add 16" to Net Unit Height.*

## DOOR HANDING

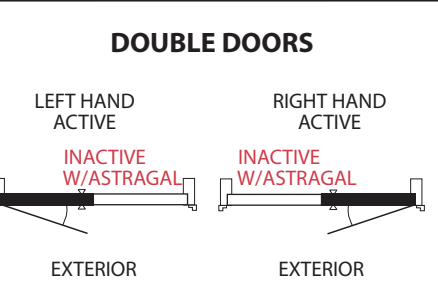
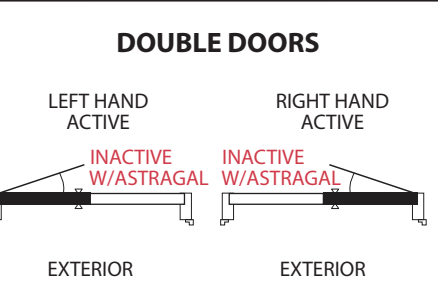
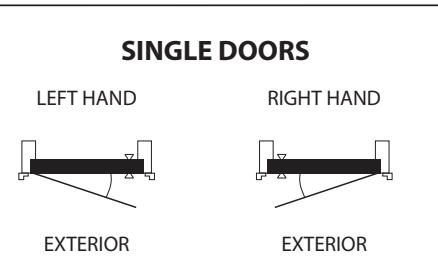
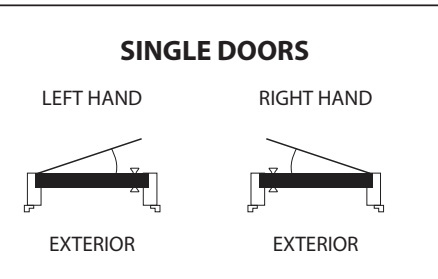
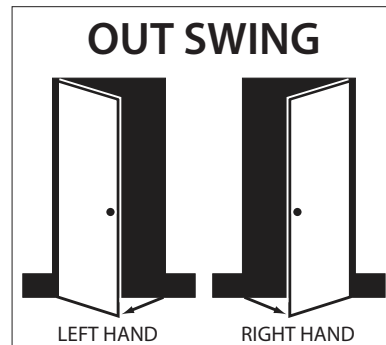
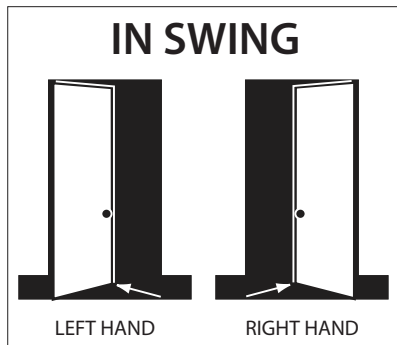

\*See page 58 for Patio Door Handing.

# Prehung Net Unit Measurements

Add 5/8" to any Net Unit Width and 3/8" to any Net Unit Height **IF IT IS AN OUTSWING** with the NAILING FLANGE.

NET UNIT WIDTHS*							NET UNIT HEIGHTS		
DOOR WIDTH	NET SLAB SIZE	NET UNIT WIDTH	PLUS 1 EACH 12" SIDELITE	PLUS 2 EACH 12" SIDELITES	PLUS 1 EACH 14" SIDELITE	PLUS 2 EACH 14" SIDELITES	FIXED OR ADJ INSWING SILL	BUMPER OUTSWING SILL	ADA LOW-PRO IN/OUT SWING SILL
2-0 x 6-8	23-3/4" x 79"	25-1/2"	38-7/8"	52-1/4"	40-7/8"	56-1/4"	81-3/4**	80-1/2**	81**
2-4 x 6-8	27-3/4" x 79"	29-1/2"	42-7/8"	56-1/4"	44-7/8"	60-1/4"	81-3/4**	80-1/2**	81**
2-6 x 6-8	29-3/4" x 79"	31-1/2"	44-7/8"	58-1/4"	46-7/8"	62-1/4"	81-3/4**	80-1/2**	81**
2-8 x 6-8	31-3/4" x 79"	33-1/2"	46-7/8"	60-1/4"	48-7/8"	64-1/4"	81-3/4**	80-1/2**	81**
2-10 x 6-8	33-3/4" x 79"	35-1/2"	48-7/8"	62-1/4"	50-7/8"	66-1/4"	81-3/4**	80-1/2**	81**
3-0 x 6-8	35-3/4" x 79"	37-1/2"	50-7/8"	64-1/4"	52-7/8"	68-1/4"	81-3/4**	80-1/2**	81**
3-6 x 6-8	41-3/4" x 79"	43-1/2"	56-7/8"	70-1/4"	58-7/8"	74-1/4"	81-3/4**	80-1/2**	81**
4-0 x 6-8	47-3/4" x 79"	49-1/2"	62-7/8"	76-1/4"	64-7/8"	80-1/4"	81-3/4**	80-1/2**	81**
4-0 x 6-8 DBL	--	50"	63-3/8"	76-3/4"	65-3/8"	80-3/4"	81-3/4**	80-1/2**	81**
4-8 x 6-8 DBL	--	58"	71-3/8"	84-3/4"	73-3/8"	88-3/4"	81-3/4**	80-1/2**	81**
5-0 x 6-8 DBL	--	62"	75-3/8"	88-3/4"	77-3/8"	92-3/4"	81-3/4**	80-1/2**	81**
5-4 x 6-8 DBL	--	66"	79-3/8"	92-3/4"	81-3/8"	96-3/4"	81-3/4**	80-1/2**	81**
5-8 x 6-8 DBL	--	70"	83-3/8"	96-3/4"	85-3/8"	100-3/4"	81-3/4**	80-1/2**	81**
6-0 x 6-8 DBL	--	74"	87-3/8"	100-3/4"	89-3/8"	104-3/4"	81-3/4**	80-1/2**	81**
7-0 x 6-8 DBL	--	86"	99-3/8"	112-3/4"	101-3/8"	116-3/4"	81-3/4**	80-1/2**	81**
8-0 x 6-8 DBL	--	98"	111-3/8"	124-3/4"	113-3/8"	128-3/4"	81-3/4**	80-1/2**	81**
2-6 x 7-0	29-3/4" x 83"	31-1/2"	44-7/8"	58-1/4"	46-7/8"	62-1/4"	85-3/4**	84-1/2**	85**
2-8 x 7-0	31-3/4" x 83"	33-1/2"	46-7/8"	60-1/4"	48-7/8"	64-1/4"	85-3/4**	84-1/2**	85**
3-0 x 7-0	35-3/4" x 83"	37-1/2"	50-7/8"	64-1/4"	52-7/8"	68-1/4"	85-3/4**	84-1/2**	85**
5-0 x 7-0 DBL	--	62"	75-3/8"	88-3/4"	77-3/8"	92-3/4"	85-3/4**	84-1/2**	85**
5-4 x 7-0 DBL	--	66"	79-3/8"	92-3/4"	81-3/8"	96-3/4"	85-3/4**	84-1/2**	85**
6-0 x 7-0 DBL	--	74"	87-3/8"	100-3/4"	89-3/8"	104-3/4"	85-3/4**	84-1/2**	85**
2-6 x 8-0	29-3/4" x 95"	31-1/2"	44-7/8"	58-1/4"	46-7/8"	62-1/4"	97-3/4**	96-1/2**	97**
2-8 x 8-0	31-3/4" x 95"	33-1/2"	46-7/8"	60-1/4"	48-7/8"	64-1/4"	97-3/4**	96-1/2**	97**
3-0 x 8-0	35-3/4" x 95"	37-1/2"	50-7/8"	64-1/4"	52-7/8"	68-1/4"	97-3/4**	96-1/2**	97**
3-6 x 8-0	41-3/4" x 95"	43-1/2"	56-7/8"	70-1/4"	58-7/8"	74-1/4"	97-3/4**	96-1/2**	97**
5-0 x 8-0 DBL	--	62"	75-3/8"	88-3/4"	77-3/8"	92-3/4"	97-3/4**	96-1/2**	97**
5-4 X 8-0 DBL	--	66"	79-3/8"	92-3/4"	81-3/8"	96-3/4"	97-3/4**	96-1/2**	97**
6-0 x 8-0 DBL	--	74"	87-3/8"	100-3/4"	89-3/8"	104-3/4"	97-3/4**	96-1/2**	97**
7-0 x 8-0 DBL	--	86"	99-3/8"	112-3/4"	101-3/8"	116-3/4"	97-3/4**	96-1/2**	97**
2-6 x EZ FIT	28-1/4" x 76-3/4"	30"	N/A	N/A	N/A	N/A	79-1/2**	78-1/4**	78-3/4**
3-0 x EZ FIT	34-1/4" x 76-3/4"	36"	N/A	N/A	N/A	N/A	79-1/2**	78-1/4**	78-3/4**
5-0 x EZ DBL	--	59"	N/A	N/A	N/A	N/A	79-1/2**	78-1/4**	78-3/4**
6-0 x EZ DBL	--	71"	N/A	N/A	N/A	N/A	79-1/2**	78-1/4**	78-3/4**

### Paint Colors



Fremont



Proctor



Cougar



Tomato



Burgundy



Hunter



Artichoke



Navy



Pacific



Ballard



Denim



Carbon



Iron



Flint



Concrete



Espresso



Truffle



Taupe



Sand

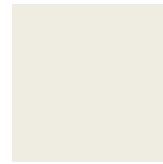

Ivory

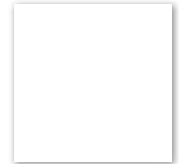

Bright

### Stain Colors



Medium Oak



Cedar



Red Cherry



Mahogany



Walnut

### Fir Grain Stain Colors



Ginger

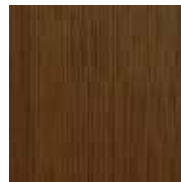

Clove

Available on Fir-Grain Doors (See pages 26-29, & 42-43).

### Flush Cherry Wood Stain Colors



Ginger



Clove

Available on Flush Cherry Doors Only (See page 19).

**Why doesn't the color on my product look exactly like it does in the catalog or website?**

*Due to the limitations of photography, there is no guarantee that your product's colors will have the same appearance as they do in print or online. We always recommend you see an actual sample before deciding on a color choice. Contact a Codel dealer to request a color chip sample.*